

MBP1100/F7

Blu-ray Disc Player



INTRODUCTION

Safety Instructions

The model and serial numbers of this unit may be found on the cabinet.
You should record and retain those numbers for future reference.

Model No.: _____

Serial No.: _____

WARNING: TO REDUCE THE RISK OF FIRE OR ELECTRIC SHOCK, DO NOT EXPOSE THIS APPARATUS TO RAIN OR MOISTURE. APPARATUS SHALL NOT BE EXPOSED TO DRIPPING OR SPLASHING AND NO OBJECTS FILLED WITH LIQUIDS, SUCH AS VASES, SHALL BE PLACED ON THE APPARATUS.



CAUTION
RISK OF ELECTRIC SHOCK
DO NOT OPEN



CAUTION:

TO REDUCE THE RISK OF ELECTRIC SHOCK, DO NOT REMOVE COVER (OR BACK). NO USER SERVICEABLE PARTS INSIDE. REFER SERVICING TO QUALIFIED SERVICE PERSONNEL.



The lightning flash with arrowhead symbol, within an equilateral triangle, is intended to alert the user to the presence of uninsulated "dangerous voltage" within the product's enclosure that may be of sufficient magnitude to constitute a risk of electric shock to persons.



The exclamation point within an equilateral triangle is intended to alert the user to the presence of important operating and maintenance (servicing) instructions in the literature accompanying the appliance.

The important note is located on the rear or bottom of the cabinet.

IMPORTANT SAFETY INSTRUCTIONS

1. Read these instructions.
2. Keep these instructions.
3. Heed all warnings.
4. Follow all instructions.
5. Do not use this apparatus near water.
6. Clean only with dry cloth.
7. Do not block any ventilation openings. Install in accordance with the manufacturer's instructions.
8. Do not install near any heat sources such as radiators, heat registers, stoves, or other apparatus (including amplifiers) that produce heat.
9. Do not defeat the safety purpose of the polarized or grounding-type plug. A polarized plug has two blades with one wider than the other. A grounding type plug has two blades and a third grounding prong. The wide blade or the third prong are provided for your safety. If the provided plug does not fit into your outlet, consult an electrician for replacement of the obsolete outlet.
10. Protect the power cord from being walked on or pinched particularly at plugs, convenience receptacles, and the point where they exit from the apparatus.
11. Only use attachments/accessories specified by the manufacturer.
12. Use only with the cart, stand, tripod, bracket, or table specified by the manufacturer, or sold with the apparatus. When a cart is used, use caution when moving the cart/apparatus combination to avoid injury from tip-over.
13. Unplug this apparatus during lightning storms or when unused for long periods of time.
14. Refer all servicing to qualified service personnel. Servicing is required when the apparatus has been damaged in any way, such as power-supply cord or plug is damaged, liquid has been spilled or objects have fallen into the apparatus, the apparatus has been exposed to rain or moisture, does not operate normally, or has been dropped.



FCC WARNING

This equipment may generate or use radio frequency energy. Changes or modifications to this equipment may cause harmful interference unless the modifications are expressly approved in the manual. The user could lose the authority to operate this equipment if an unauthorized change or modification is made.

RADIO-TV INTERFERENCE

This equipment has been tested and found to comply with the limits for a Class B digital device, pursuant to Part 15 of the FCC Rules. These limits are designed to provide reasonable protection against harmful interference in a residential installation. This equipment generates, uses, and can radiate radio frequency energy and, if not installed and used in accordance with the instructions, may cause harmful interference to radio communications. However, there is no guarantee that interference will not occur in a particular installation. If this equipment does cause harmful interference to radio or television reception, which can be determined by turning the equipment off and on, the user is encouraged to try to correct the interference by one or more of the following measures:

- 1) Reorient or relocate the receiving antenna.
- 2) Increase the separation between the equipment and receiver.
- 3) Connect the equipment into an outlet on a circuit different from that to which the receiver is connected.
- 4) Consult the dealer or an experienced radio/TV technician for help.

This Class B digital apparatus complies with Canadian ICES-003.

Disconnect the mains plug to shut off when find trouble or not in use. The mains plug shall remain readily operable.

INTRODUCTION

CAUTION: Danger of explosion if battery is incorrectly replaced. Replace only with the same or equivalent type.
WARNING: Batteries (Battery pack or battery installed) shall not be exposed to excessive heat such as sunshine, fire, or the like.

LASER SAFETY

This apparatus employs a laser. Only a qualified service person should remove the cover or attempt to service this apparatus, due to possible eye injury.

CAUTION: Use of controls or adjustments or performance of procedures other than those specified herein may result in hazardous radiation exposure.

CAUTION: Visible and invisible laser radiation when open and interlocks defeated. Do not stare into beam.

LOCATION: Inside, near the deck mechanism.

IMPORTANT COPYRIGHT INFORMATION

Unauthorized copying, broadcasting, public performance and lending of discs are prohibited. This product incorporates copyright protection technology that is protected by U.S. patents and other intellectual property rights. Use of this copyright protection technology must be authorized by Macrovision, and is intended for home and other limited viewing uses only unless otherwise authorized by Macrovision. Reverse engineering or disassembly is prohibited.

Do not place the unit on the furniture that is capable of being tilted by a child and an adult leaning, pulling, standing or climbing on it. A falling unit can cause serious injury or even death.

To Avoid the Hazards of Electrical Shock and Fire

- Do not handle the AC power cord with wet hands.
- Do not pull on the AC power cord when disconnecting it from an AC outlet. Grasp it by the plug.
- Do not put your fingers or objects into the unit.

Location and Handling

- Do not install the unit in direct sunlight, near strong magnetic fields, or in a place subject to dust or strong vibration.
- Avoid a place with drastic temperature changes.
- Install the unit in a horizontal and stable position. Do not place anything directly on top or bottom of the unit. Depending on your external devices, noise or disturbance of the picture and/or sound may be generated if the unit is placed too close to them. In this case, please ensure enough space between the external devices and the unit.
- Depending on the environment, the temperature of this unit may increase slightly. This is not a malfunction.
- Be sure to remove the disc and unplug the AC power cord from the outlet before carrying the unit.

Dew Condensation Warning

- Dew condensation may form inside the unit in the following conditions. If so, do not use this unit at least for a few hours until its inside gets dry.
 - The unit is moved from a cold place to a warm place.
 - Under conditions of high humidity.
 - After heating a cold room.

Note about Recycling

- This unit's packaging materials are recyclable and can be reused. Please dispose of any materials in accordance with your local recycling regulations.
- Batteries should never be thrown away or incinerated but disposed of in accordance with your local regulations concerning chemical wastes.



Notice for Progressive Scan Output

- Consumers should note that not all high definition television sets are fully compatible with this product and may cause artifacts to be displayed in the picture. In case of picture problems with 525(480) progressive scan output, it is recommended that the user switch the connection to the 'standard definition' output. If there are questions regarding your TV set compatibility with this 525p(480p) BD/DVD player, please contact our customer service center.

INTRODUCTION

Contents

INTRODUCTION

Safety Instructions	2
Supplied Accessories	5
Trademark Information	5
Features	6
Symbols Used in this Manual	6
Front Panel.....	7
Rear Panel.....	7
Remote Control.....	8

CONNECTIONS

Connection to the TV	10
Connection to an Audio System	12
Finding the Video Channel on Your TV	13

PLAYBACK

Information on Playback.....	14
How to Insert a Disc.....	17
Reading the SD Memory Card	17
Selecting the Media Mode	18
Playing Back (BD / DVD).....	19
Playing Back (Audio CD / JPEG Files)	20
Kodak Picture CD.....	21
Fast Forward / Fast Reverse	22
Slow Forward Playback	22
Step by Step Playback	22
Repeat Playback.....	22
Program Playback	23
Random Playback.....	24
Rapid Playback	24
Adjusting the Picture	24
Virtual Surround.....	25
PIP (BONUSVIEW) Setting	25
Camera Angle	25
Search	26
Switching Subtitles	27
Switching Audio Soundtrack	27
Setting the BD Audio Mode.....	28

FUNCTION SETUP

Using the Setup Menu	29
Quick.....	29
Custom	30
Language.....	31
Video	32
Audio	34
Parental	39
Others.....	40
Initialize	44

OTHERS

Troubleshooting.....	45
Glossary	46
Language Code List.....	47
Maintenance.....	49
LIMITED WARRANTY	back cover

INTRODUCTION

Supplied Accessories

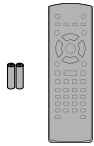

remote control × 1
(NB950UD/NB900UD)
AAA (1.5V) battery × 2

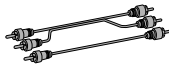

RCA audio / video cables
(WPZ0102TM018 /
WPZ0102LTE01)

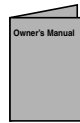

owner's manual (EN/ES/FR)
(1VMN28573 /1VMN28574 /
1VMN28575)



quick start guide (EN/ES/FR)
(1VMN28576 / 1VMN28577 /
1VMN28578)

Trademark Information



HDMI, the HDMI logo and High-Definition Multimedia Interface are trademarks or registered trademarks of HDMI Licensing LLC.



Manufactured under license from Dolby Laboratories. Dolby and the double-D symbol are trademarks of Dolby Laboratories.



Manufactured under license under U.S. Patent #'s: 5,451,942; 5,956,674; 5,974,380; 5,978,762; 6,487,535 & other U.S. and worldwide patents issued & pending. DTS is a registered trademark and the DTS logos, Symbol, DTS-HD and DTS-HD Advanced Digital Out are trademarks of DTS, Inc. © 1996-2008 DTS, Inc. All Rights Reserved.

"Blu-ray Disc" and  are trademarks.

 is a trademark of DVD Format/Logo Licensing Corporation.

BONUS VIEW™

"BONUSVIEW" is trademark of Blu-ray Disc Association.



Java and all other Java trademarks and logos are trademarks or registered trademarks of Sun Microsystems, Inc. in the United States and / or other countries.



Products that have earned ENERGY STAR® are designed to protect the environment through superior energy efficiency.



is trademark of Eastman Kodak Company.

© 2009 Funai Electric Co., Ltd.

All rights reserved. No part of this manual may be reproduced, copied, transmitted, disseminated, transcribed, downloaded or stored in any storage medium, in any form or for any purpose without the express prior written consent of Funai. Furthermore, any unauthorized commercial distribution of this manual or any revision hereto is strictly prohibited.

Information in this document is subject to change without notice. Funai reserves the right to change the content herein without the obligation to notify any person or organization of such changes.

FUNAI with the  design is a registered trademark of Funai Electric Co., Ltd and may not be used in any way without the express written consent of Funai. All other trademarks used herein remain the exclusive property of their respective owners. Nothing contained in this manual should be construed as granting, by implication or otherwise, any license or right to use any of the trademarks displayed herein. Misuse of any trademarks or any other content in this manual is strictly prohibited. Funai shall aggressively enforce its intellectual property rights to the fullest extent of the law.

INTRODUCTION

Features

Full high-definition video playback

Watch movies in the highest picture quality available for your HDTV. This unit offers full high-definition video playback up to 1080p resolution for an amazing viewing experience. A highly detailed picture and increased sharpness delivers a more true-to-life picture.

Upconvert DVD for enhanced picture quality

Your current DVD will look even better than before thanks to video upconversion. Upconversion will increase the resolution of standard definition DVD to high definition up to 1080p over an HDMI connection. The picture will be less jagged and more realistic for a near high-definition experience.

Enjoy your content on different kinds of media

Full backwards compatibility with DVD, CD and SD card ensures that you can continue to enjoy your current audio-video collection. Additionally, you can view JPEG images.

Listen to the rich multi-channel surround sound

Multi-channel surround sound, which recognizes real-to-life sound and makes you feel like you are really there.

PIP (BONUSVIEW)

Some BD-videos have the PIP function which enables you to display the secondary video in the primary video. You can call up the secondary video by pressing **[MODE]** whenever the scene contains the secondary video.

Pop-up menu

Some BD-video have pop-up menu which is a navigation menu that can be called up and be operated on the TV screen without interrupting the playback. You can call up the pop-up menu by pressing **[POP MENU / MENU]**. Contents in the pop-up menu vary depending on the disc.

Rapid playback

Playback in slightly faster speed while keeping the sound output.

Rapid playback is available only on discs recorded in the Dolby Digital format.

Playing back the contents in SD Memory Card

You can play back JPEGs stored in an SD Memory Card. You can store picture-in-picture commentary, subtitles or other extras for BD-ROM Profile 1 ver.1.1 files in an SD Memory Card and play back with the BD-video.

Easy and simple connection to your HDTV via HDMI

Connect this unit to your HDTV with one single HDMI (High-Definition Multimedia Interface) cable. It is recommended to use a High Speed HDMI Cable for better compatibility. The high definition video output signal will be transferred to your HDTV without conversion to analog signals, so you will get excellent picture and sound quality, completely free from noise.

Thanks to other multiple outputs, you can also easily connect to your home theater system or amplifier.

HDMI Deep Color

Deep Color reduces the posterization effect of the playback image. Refer to "HDMI Deep Color" in "FUNCTION SETUP" on page 32.

HDMI CEC (Consumer Electronics Control)

This unit supports HDMI CEC, which allows integrated system control over HDMI and is part of the HDMI standard.

This function may not work properly on some devices.

HDMI 1080p24 output (BD only)

This unit is equipped with a feature which can provide the smooth movement in the playback of film originated material with the frame rate of 24 frames per second with progressive scan. (Available only when the TV is connected by an HDMI cable and compatible with 1080p24 frame input.)





Refer to "HDMI Video Resolution" in "FUNCTION SETUP" on page 32.

Copyright protection system

To play back the digital video images of a BD / DVD via an HDMI connection, it is necessary that both the unit and the TV (or an AV amplifier) support a copyright protection system called HDCP (high-bandwidth digital content protection system). HDCP is copy protection technology that comprises data encryption and authentication of the connected AV device. This unit supports HDCP. Please read the operating instructions of your TV (or AV amplifier) for more information.

Symbols Used in this Manual

To specify for which media type each function is, we put the following symbols at the beginning of each item to operate.

Symbol	Description
	Description refers to BD-video and BD-RE (ver.2.1) / BD-R (ver.1.1/1.2/1.3) recorded in BDMV format
	Description refers to DVD-video
	Description refers to audio CD / DTS-CD
	Description refers to BD-RE/-R, DVD, CD-RW/-R and SD Memory Card with JPEG files

If you do not find any of the symbols listed above under the function heading, the operation is applicable to all media.

Front Panel

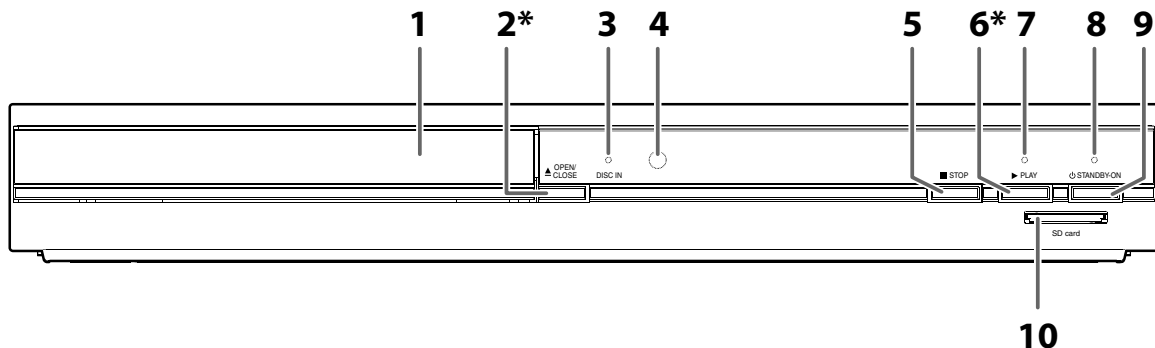

(*) The unit can also be turned on by pressing these buttons.

1. Disc tray

- Place a disc when opening the disc tray.

2. ▲ OPEN/CLOSE button*

- Press to open or close the disc tray.

3. DISC IN indicator

- This indicator lights up in blue when a disc is in this unit.

4. Infrared sensor window

- Receive signals from your remote control so that you can control the unit from a distance.

5. ■ STOP button

- Press to stop playback.

6. ► PLAY button*

- Press to start or resume playback.

7. PLAY indicator

- This indicator lights up in green when discs or SD card play back.

8. STANDBY-ON indicator

- This indicator lights up in red when the power is in the standby mode.

9. ⏻ STANDBY-ON button

- Press to turn on the unit, or to turn the unit into the standby mode. (To completely turn off the unit, you must unplug the AC power cord.)
- Press and hold for 10 seconds to shut down the unit.

10. SD card slot

- Insert an SD Memory Card and play back the contents in it.

Rear Panel

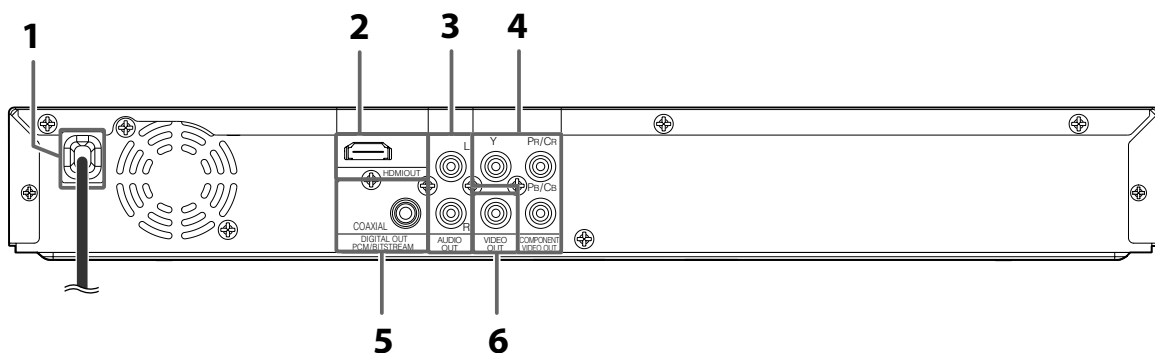

1. AC power cord

- Connect to a standard AC outlet to supply power to this unit.
- Unplug this cord from the AC outlet to completely turn off the unit.

2. HDMI OUT jack

- Use to connect a TV with an HDMI compatible port with an HDMI cable.

3. AUDIO OUT jacks

- Use to connect a TV, an AV receiver / amplifier or other device with an RCA audio cable.

4. COMPONENT VIDEO OUT jacks

- Use to connect a TV with component video inputs with an RCA component video cable.

5. DIGITAL OUT (COAXIAL) jack

- Use to connect an AV receiver / amplifier, Dolby Digital / DTS decoder or other device with a digital audio coaxial input jack with a digital audio RCA cable.

6. VIDEO OUT jack

- Use to connect a TV, an AV receiver or other device with an RCA video cable.

Note

- Do not touch the inner pins of the jacks on the rear panel. Electrostatic discharge may cause permanent damage to the unit.
- This unit does not have the RF modulator.

Remote Control

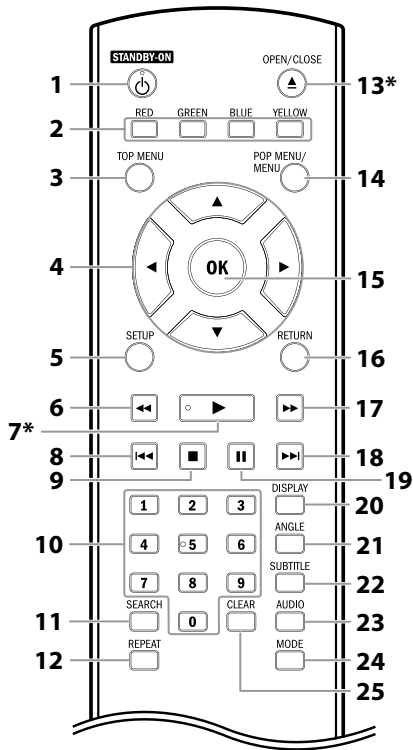

(*) The unit can also be turned on by pressing these buttons.

1. STANDBY-ON button

- Press to turn on the unit, or to turn the unit into the standby mode. (To completely turn off the unit, you must unplug the AC power cord.)

2. RED / GREEN / BLUE / YELLOW button

- Press to select items on some BD menus.
- When file list / thumbnail list is shown, press to switch between pages.

3. TOP MENU button

- Press to display the top menu.

4. / / / buttons

- Press to select items or settings.

5. SETUP button

- Press to display the setup menu.

6. (reverse) button

- During playback, press to fast reverse the playback.

7. (play) button*

- Press to start playback or resume playback.

8. (skip) button

- During playback, press once to return to the beginning of the current title, chapter or track.
- During playback, press twice to return to the previous title, chapter or track.
- During the JPEG playback, press to return to the previous file.

9. (stop) button

- Press to stop playback.

10. Number buttons

- Press to enter the title, chapter, track or file number.
- Press to enter values in the input field.

11. SEARCH button

- Press to display the search menu.

12. REPEAT button

- Press to toggle between various repeat modes.

13. OPEN/CLOSE button*

- Press to open or close the disc tray.

14. POP MENU / MENU button

- Press to display the pop-up menu / disc menu.

15. OK button

- Press to confirm or select menu items.

16. RETURN button

- Press to return to the previously displayed menu screen.

17. (forward) button

- During playback, press to fast forward the playback.
- In pause mode, press to slow forward the playback.

18. (skip) button

- During playback, press to skip to the next title, chapter, track or file.

19. (pause) button

- Press to pause playback.
- When playback is in pause mode, press repeatedly to forward the playback step by step.

20. DISPLAY button

- Press to display the on-screen display menu.

21. ANGLE button

- Press to access various camera angles on the disc.
- Press to rotate the JPEG files clockwise by 90 degrees.

22. SUBTITLE button

- Press to display the subtitle menu.

23. AUDIO button

- Press to display the audio menu.

24. MODE button

- During BD or DVD playback, press to display the setting for the rapid playback and the picture adjustment.
- During BD, DVD and CD playback, press to display the setting for the virtual surround.
- During BD playback, press to turn the picture-in-picture feature on or off (only applicable to BD-video which supports the PIP function).
- During the JPEG playback, press to display menus for changing the visual effect for switching the image or changing the size of the image.
- In stop mode with BD inserted, press to display a menu for setting the BD audio mode.
- In stop mode with audio CD or JPEG files inserted, press to display menus for program and random playback.

25. CLEAR button

- Press to clear the information once entered or to cancel the programming for audio CD, etc.

Installing the Batteries in the Remote Control

Install AAA (1.5V) battery × 2 matching the polarity indicated inside battery compartment of the remote control.

1) Open the cover.

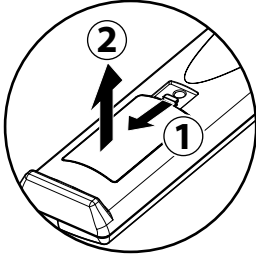

2) Insert batteries.

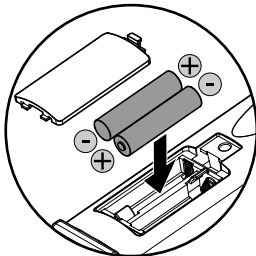

Make sure to match + and - on the batteries to the marks indicated in the battery compartment.

3) Close the cover.

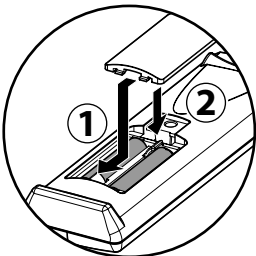

Note

Incorrect use of batteries can result in hazards such as leakage and bursting. Please observe the following:

- Do not mix new and old batteries together.
- Do not use different kinds of batteries together. Although they may look similar, different batteries may have different voltages.
- Make sure that the + and - ends of each battery match the indications in the battery compartment.
- Remove batteries from battery compartment that are not going to be used for a month or more.
- When disposing of used batteries, please comply with governmental regulations or environmental public rules that apply in your country or area. (Refer to page 3.)
- Do not recharge, short-circuit, heat, burn or disassemble batteries.

Using a Remote Control

Keep in mind the following when using the remote control:

- Make sure that there are no obstacles between the remote control and the infrared sensor window on the unit.
- Remote operation may become unreliable if strong sunlight or fluorescent light is shining on the infrared sensor window of the unit.
- Remote control for different devices can interfere with each other. Avoid using remote control for other device located close to the unit.
- Replace the batteries when you notice a fall off in the operating range of the remote control.
- The maximum operable ranges from the unit are as follows.
 - **Line of sight:** approx. 23 feet (7 m)
 - **Either side of the center:** approx. 16 feet (5 m) within 30°
 - **Above:** approx. 16 feet (5 m) within 15°
 - **Below:** approx. 10 feet (3 m) within 30°

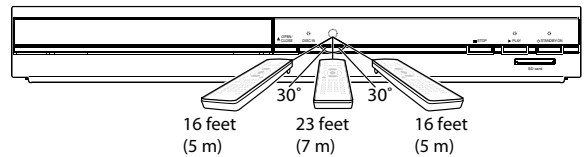

CONNECTIONS

Connection to the TV

- 1 Choose the appropriate connection, then proceed to the corresponding instruction (A, B or C) on the next page.

Best (Supports up to 1080i / 1080p, 1080p24 resolution.)

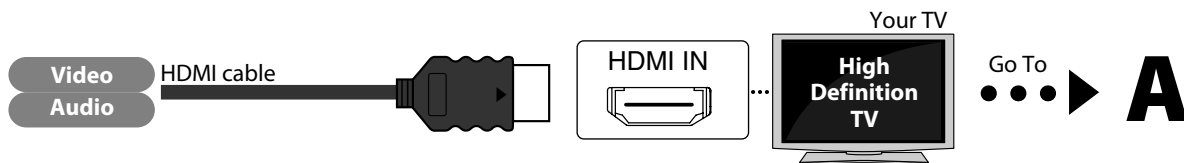

No analog audio connection required.

No supplied cables are used in this connection:

Please purchase the necessary cables at your local store.

High Speed HDMI Cable (also known as HDMI category 2 cable) is recommended for the better compatibility.

Better (Supports up to 1080i resolution.)

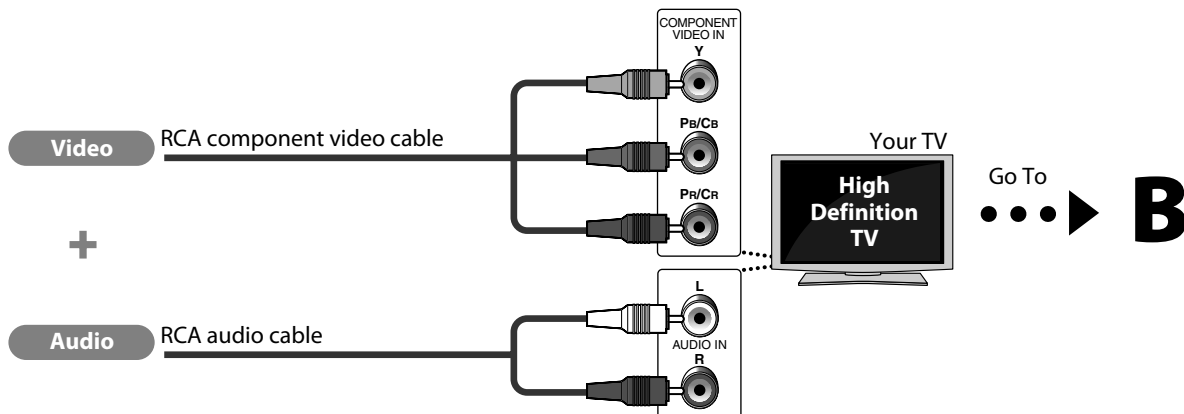

Supplied cables used in this connection are as follows:

- RCA audio cable (L/R) x 1

Please purchase the rest of the necessary cables at your local store.

Basic (Supports only 480i resolution.)

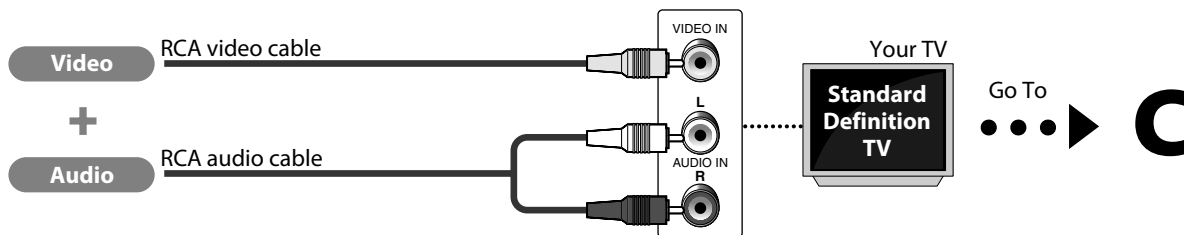

- Connect this unit directly to the TV. If the RCA audio / video cables are connected to a VCR, pictures may be distorted due to the copy right protection system.

Supplied cables used in this connection are as follows:

- RCA audio cable (L/R) x1
- RCA video cable x1

2 Connect the cables by following the descriptions below.

HDMI Video / Audio Connection

A

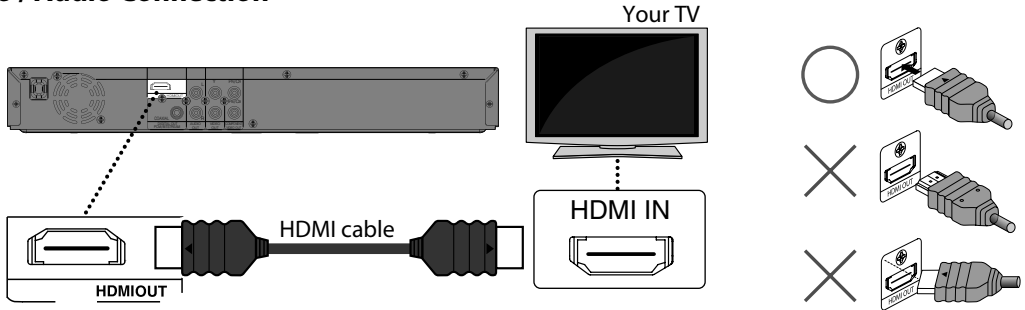

Note

- Do not tilt the connector when inserting it into the HDMI jack, and make sure the shapes of the jack and the connector are matched.
- When using HDCP-incompatible TV, the image will not be viewed properly.

Not displayed the picture on the TV screen ...

The indicators blink under the following conditions.

- When the connected device does not support HDCP.
- When the connected device is recognized as an HDCP incompatible by HDMI SRM.
- When the connected device supports HDCP but cannot be recognized as an HDCP compatible for some reason.

The indicators blink as follows for 30 seconds.

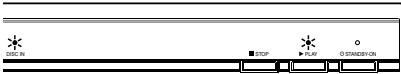

Component Video + Standard Audio Connection

B

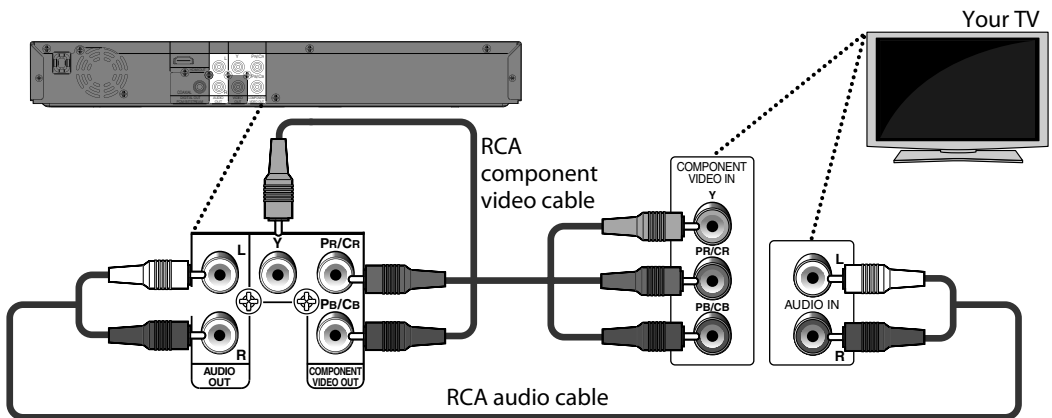

Standard Video + Standard Audio Connection

C

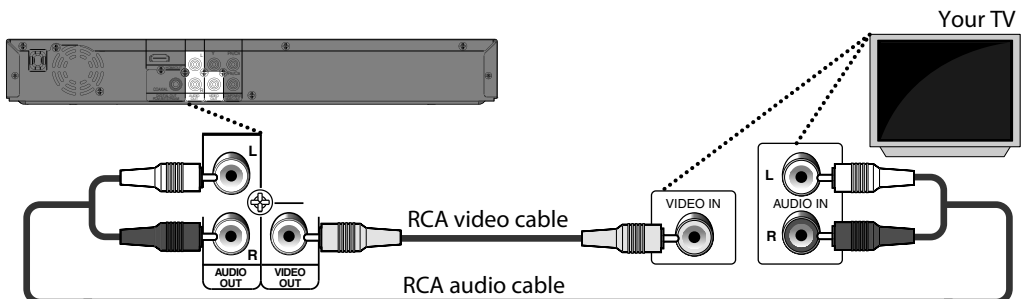

CONNECTIONS

Connection to an Audio System

- When you change the connections, all devices should be turned off.
- Refer to the manual accompanying external devices for more information.

2-Channel Analog Audio Connection

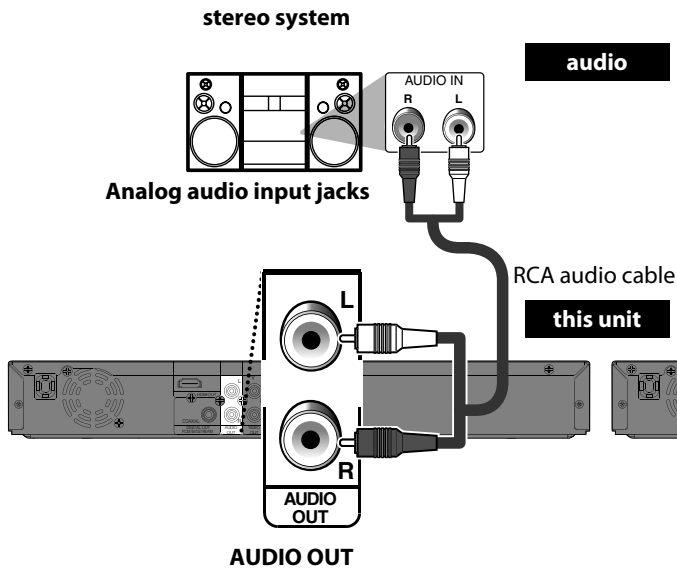

Digital Audio Connection

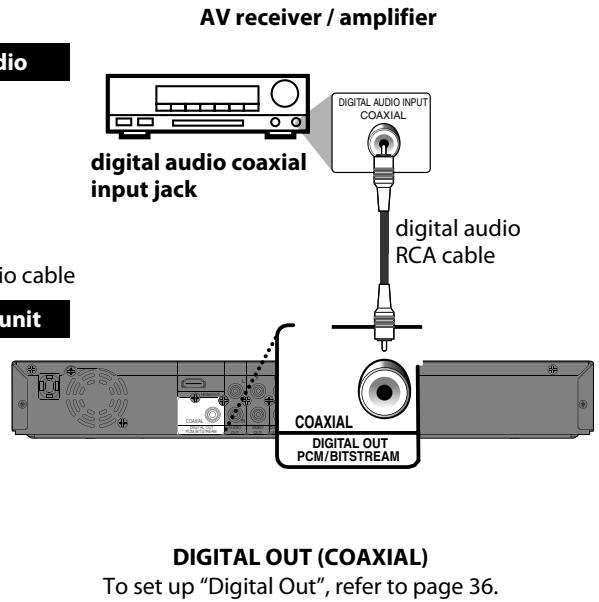

HDMI Audio Connection

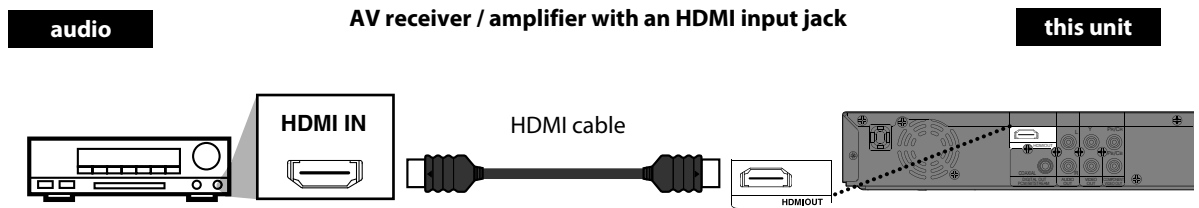

To set up "HDMI Audio Out", refer to pages 35 and 34.

Supplied cables used in this connections are as follows:

- RCA audio cable (L/R) x 1
- Please purchase the rest of the necessary cables at your local store.

CONNECTIONS

After you have completed all the connections, you must find the correct video channel (external input channel) on your TV.

Finding the Video Channel on Your TV

- 1** After you have made all the necessary connections, press [STANDBY-ON ] to turn on the unit.
- 2** Turn on your TV.
- 3** Press the button on the TV's remote control that accesses the external input channel. It may be labeled "SOURCE", "AV" or "SELECT" (refer to your TV's user manual).



Note

- If the TV is connected by an HDMI cable, it may take a while for the opening picture to come up.

PLAYBACK

Information on Playback

Before you start playing back a disc, read the following information.

Playable Discs and Files

This unit is compatible to play back the following discs / files. To play back a disc / file, make sure that it meets the requirements for region codes and color systems as described below. You can play back discs that have the following logos.

Other disc types are not guaranteed to play back.

Playable discs	Logos
Blu-ray Disc - BD-video (single / dual layer) - BD-RE ver. 2.1 (single / dual layer) (Recorded in BDMV format) - BD-R ver. 1.1 / 1.2 / 1.3 (single / dual layer) (Recorded in BDMV format) (Unclosed discs may not be played back.)	
DVD-video	
DVD-RW	
DVD-R	
CD-DA (audio CD)	
CD-RW	 
CD-R	 
Kodak Picture CD	
DTS-CD	-

Playable files	Media
JPEG	BD-RE/-R, DVD, CD-RW/-R, SD Memory Card (including SDHC), miniSD Card, microSD Card

Readable cards	Playable files / data
SD Memory Card (8 MB - 2 GB)	JPEG, picture-in-picture
SDHC Memory Card (4 GB - 8 GB)	commentary, subtitles or other extras for BD-ROM
miniSD Card (8 MB - 2 GB)	Profile 1 ver.1.1
microSD Card (8 MB - 2 GB)	

Note for SD Memory Cards

- This unit supports SD Memory Card with FAT12/ FAT16 file system, and SDHC Memory Card with FAT32 file system.
- This unit does not support NTFS file system.
- This unit may not read the SD Memory Cards formatted on a computer. If that is the case, please reformat the SD Memory Cards in this unit and try again.
- This unit does not support miniSDHC and microSDHC Memory Card.
- For miniSD Card and microSD Card, the adapter is necessary.

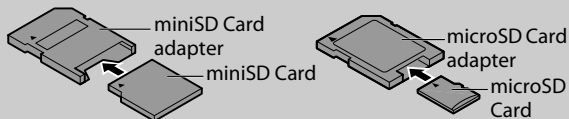

- Portions of this product are protected under copyright law and are provided under license by ARIS / SOLANA / 4C.
- Please keep the SD Memory Cards in their cases when you are not using them.
- Do not try to open or modify the card.
- Do not touch the terminal surface with your fingers or any metals.
- Do not attach additional labels or stickers to cards.
- Do not remove the label of the SD Memory Cards.
- This unit recognizes up to 8 characters of file name in the SD Memory Card. Characters after 8th will not be displayed.

Unplayable Discs and Files

The following discs will not be played back in this unit.

- CD-ROM
- CD-I (compact disc-interactive)
- DVD-RAM
- VSD (video single disc)
- DVD-audio
- Video CD
- HD DVD
- SVCD
- Unfinalized disc
- BD-RE (ver.1.0)
- BD-RE (ver.2.1) (Recorded in BDAV format)
- BD-R (ver.1.1 / 1.2 / 1.3) (Recorded in BDAV format)
- DVD / CD / SD Memory Card contains MP3, Windows Media™ Audio and DivX® files.
- DVD-RW/-R recorded in non compatible recording format.
- Super Audio CD - Only the sound on the CD layer can be heard. The sound on the high-density Super Audio CD layer cannot be heard.
- Playability of dual discs are not guaranteed.

Color Systems

BD-video and DVD-video are recorded in different color systems throughout the world. The most common color system is NTSC (which is used primarily in the United States and Canada).

This unit employs NTSC color system, so the disc you play back must be recorded in the NTSC system. You cannot play back the disc recorded in other color systems.

Region Codes

This unit has been designed to play back BD-video with region "A" and DVD-video with region "1" or "ALL". You cannot play back BD-video or DVD-video that are labeled for other regions. Look for the symbols on the right on your BD-video or DVD-video.

If these region symbols do not appear on your BD-video or DVD-video, you cannot play back the disc in this unit. The letter or number inside the globe refers to region of the world. A BD-video or DVD-video labeled for a specific region can only be played back in the unit with the same region code.

BD-video



DVD-video



On-Screen Display

You can check information about the current disc by pressing [**DISPLAY**].

To call the on-screen display menu, press [**DISPLAY**] during playback. Every time you press [**DISPLAY**], the information changes. Depending on the media, available information varies.



- off → Title / Chapter information
- Title information (elapsed time)
- Title information (remaining time)
- Audio format information → off



- off → Chapter information (elapsed time)
- Chapter information (remaining time)
- Title information (elapsed time)
- Title information (remaining time)
- Audio format information → off



- Track information (elapsed time)
 - Track information (remaining time)
 - Disc information* (elapsed time)
 - Disc information* (remaining time)
 - Track information (elapsed time)
- (* not available during program / random playback)



- off → File information → File name information → off

Structure of Disc / SD Memory Card Contents

The contents of BD / DVD are generally divided into titles. Titles may be further subdivided into chapters.

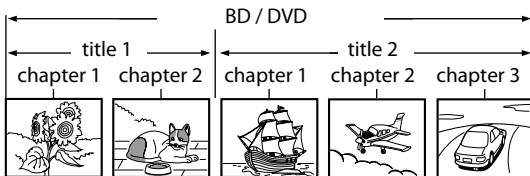

audio CD are divided into tracks.



Data discs or SD Memory Cards containing JPEG are divided into folders, and the folders are subdivided into files.

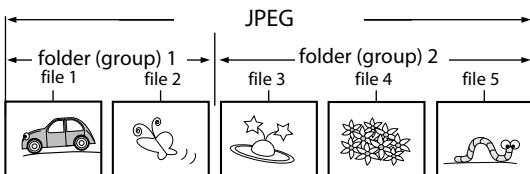

PLAYBACK

■ Chapter information

<Title / Chapter information for BD>



<Chapter information for DVD>



- 1 Current title number
- 2 Current chapter number / Total number of chapters
- 3 Current repeat setting (Only when repeat setting is active)
(C: Chapter repeat, T: Title repeat)
- 4 Indicates that the multi camera angle images are available on the scene
- 5 Current playback status
- 6 Elapsed time / Remaining time of the current chapter

■ Title information



- 1 Current title number / Total number of titles
- 2 Elapsed time / Remaining time of the current title

■ Track / File information



- 1 Current track (file) number / Total number of track (file)
- 2 Elapsed time / Remaining time of the current track (except for JPEG files)
- 3 Indication of SD Memory Card playback
- 4 Current repeat setting
(Only when repeat setting is active)
(T: Track repeat, G: Group repeat, A: All repeat)

■ Disc information



- 1 Current track number / Total number of tracks
- 2 Elapsed time / Remaining time of the current disc

■ File name information



- 1 Media icon and file name

 : JPEG file

■ Audio format information



- 1 Audio format

How to Insert a Disc

1 Press [OPEN/CLOSE ▲] to open the disc tray.

2 Place the disc on the disc tray with its label side facing up.

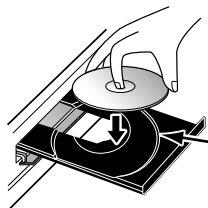

Align the disc to the disc tray guide.

- Make sure the disc is compatible with this unit. (Refer to page 14 for the list of compatible discs.)

3 Press [OPEN/CLOSE ▲] to close the disc tray.

It may take a while to load the disc.

To eject the disc:

Press [OPEN/CLOSE ▲] to open the disc tray.

Remove the disc.

Press [OPEN/CLOSE ▲] to close the disc tray.

Reading the SD Memory Card

JPEG

You can play back the JPEG files in an SD Memory Card. With the SD Memory Card, you can also enjoy the special additional contents for BD-ROM Profile 1 ver.1.1 which can be downloaded from the Internet. You can store the contents on an SD Memory Card via computer and play them back with the BD-video. For more information about the special additional contents, please refer to the instruction book that came with the disc.

1 Insert an SD Memory Card, with the label side facing up, into the SD card slot until it clicks.

If no disc is in operation, "Media Select" screen will appear on the TV screen.

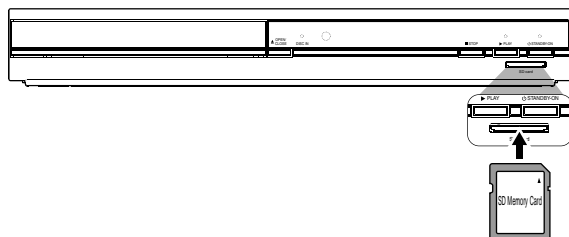

2 Use [▲ / ▼] to select "SD Card", then press [OK].

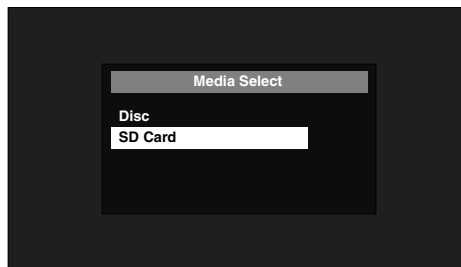

3 Use [▲ / ▼] to select a desired track, folder or file, then press [OK]. Use [◀ / ▶] to go back and forward between the hierarchies.

- If you press [OK] on the desired file, playback will start.

To remove the SD Memory Card:

In stop mode, gently push in the SD Memory Card, then pull it out slowly.

Note

- The "Media Select" screen will disappear under the conditions listed below:
 - when the screen saver is activated.
 - when [RETURN] is pressed.
 - when the setup menu is called up.
- If the "Media Select" screen disappears before you make the selection, refer to "Selecting the Media Mode" on page 18.
- Do not remove the SD Memory Card or turn the unit to the standby mode while the contents of the card are in playback. It may result in malfunction or loss of the card's data.
- Do not delete the folders or files in the SD Memory Card with your computer. This unit may not read the SD Memory Cards formatted on a computer.

PLAYBACK

Selecting the Media Mode

For the playback media to be read by this unit, the correct media mode should be selected. You can switch the media mode by following the steps below. **"Media Select" is available only when an SD Memory Card is inserted.**

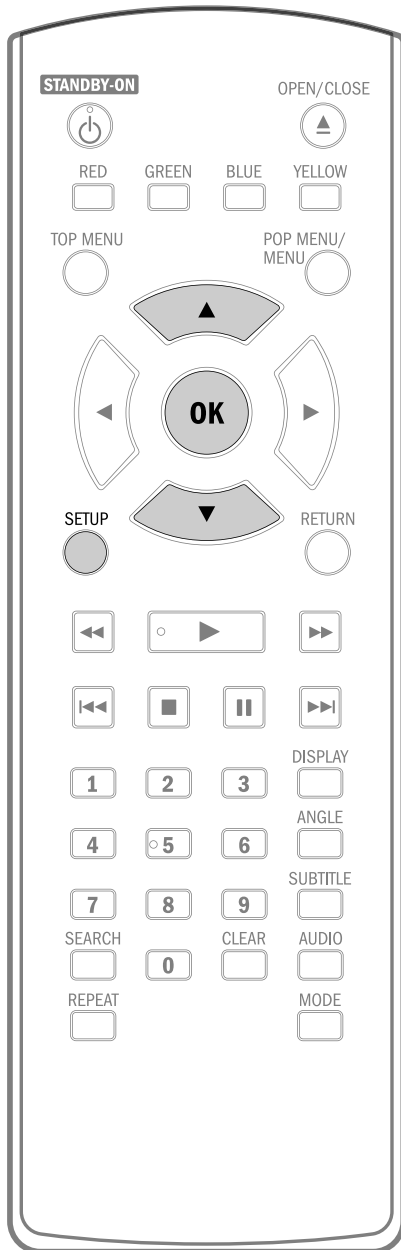

1 In stop mode, press [SETUP].

2 Use [▲ / ▼] to select , then press [OK].

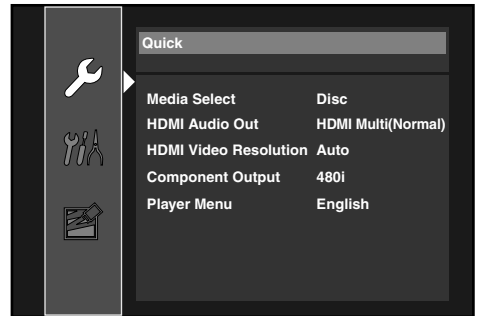

3 Use [▲ / ▼] to select "Media Select".

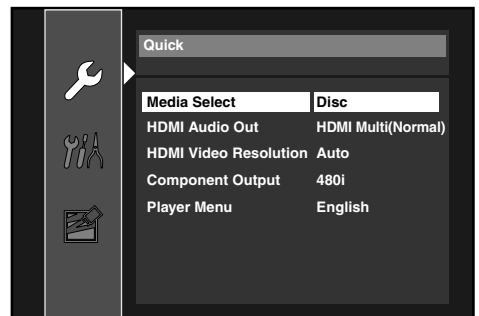

4 Press [OK] repeatedly to select the desired media.

5 Press [SETUP] to exit.
• Selected media mode is now activated.

Even if you turn the unit to the standby mode in "SD Card" mode, it will be in "Disc" mode the next time you turn it on.

Playing Back (BD / DVD)

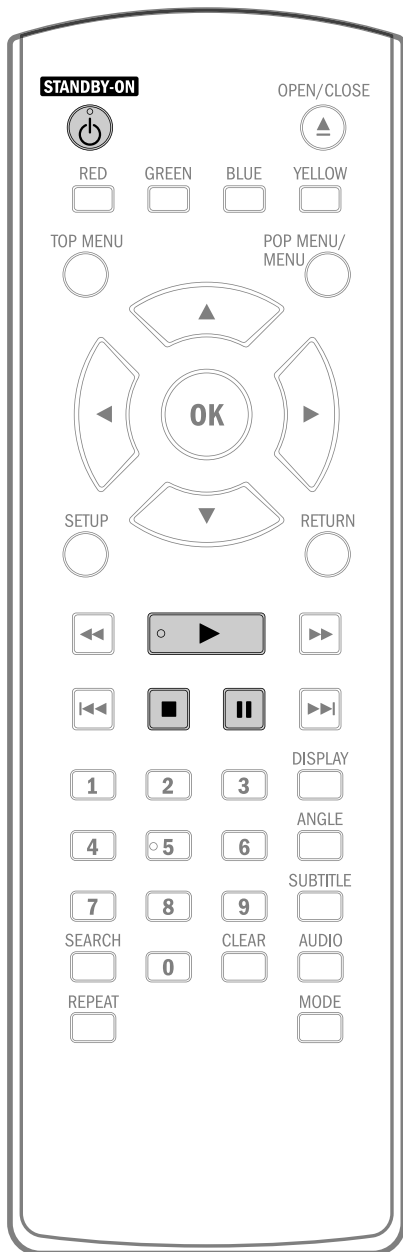

- 1** Press [STANDBY-ON].
- 2** Turn on the TV and select the appropriate input on the TV to which the unit is connected.
- 3** Insert a disc (refer to page 17 on how to insert a disc).
- 4** Playback may start automatically.
If not, press [▶ (play)].
Some discs may show a title or a disc menu. In such case, refer to "Using the Title / Disc / Pop-up Menu" on page 20.
To pause playback:
Press [⏸ (pause)].
To return to the normal playback:
Press [▶ (play)].
To stop playback:
Press [■ (stop)].
Playback will be in Resume-On-Stop mode.

Resume-On-Stop mode

If a playback is in Resume-On-Stop mode, when you press [▶ (play)] next time, the playback will start from the point where it has been stopped.

Note

- Resume playback may not be available for the BD that supports Java applications (BD-Java).
- In the "Disc" mode, the resume information will be cleared when;
 - [■ (stop)] is pressed while in the Resume-On-Stop mode.
 - the parental level is changed.
 - the disc tray is opened.
- In the "SD Card" mode, the resume information will be cleared when;
 - [■ (stop)] is pressed while in the Resume-On-Stop mode.
 - the SD Memory Card is removed.
 - the unit is turned into the standby mode.

Note

- may appear at the top-right on the TV screen when the operation is prohibited by the disc or this unit.
- During the playback of 2-layered disc, pictures may stop for a moment. This happens when the 1st layer switches to the 2nd layer. This is not a malfunction.
- The operation may vary when you play back BD-video and DVD-video with disc menu. Refer to the manual accompanying the disc for details.
- Set "Still Mode" setting to "Field" in "Video" menu if pictures in the pause mode are blurred. Refer to "Still Mode" on page 33.

PLAYBACK

Using the Title / Disc / Pop-up Menu



Many of BD-video and DVD-video discs contain title menu (BD-video / DVD-video), disc menu (DVD-video) or pop-up menu (BD-video) which guides you through the available functions in the disc. The contents of the menus may differ depending on the discs.

Title menu (BD-video / DVD-video)

- 1 Press [TOP MENU].
- 2 Use [▲ / ▼ / ◀ / ▶] to select an item, then press [OK].
- 3 Press [TOP MENU] to exit.

Disc menu (DVD-video)

- 1 Press [POP MENU / MENU].
- 2 Use [▲ / ▼ / ◀ / ▶] to select an item, then press [OK].
- 3 Press [POP MENU / MENU] to exit.

Pop-up menu (BD-video)

- This is a special feature available for some BD-videos. When you press [POP MENU / MENU], a menu pops out on the TV screen during play back.

- 1 During the playback of BD-video, press [POP MENU / MENU].
- 2 Use [▲ / ▼ / ◀ / ▶] to select an item, then press [OK].
- 3 Press [POP MENU / MENU] to exit.

Note

- Contents of menus and corresponding menu operations may vary among discs. Refer to the manual accompanying the disc for details.

Playing Back (Audio CD / JPEG Files)



Before you begin, make sure the correct media mode is selected. Refer to “Selecting the Media Mode” on page 18.

- 1 Insert an audio CD or a disc/card with JPEG files.
- 2 Use [▲ / ▼] to select a desired track, folder or file, then press [OK]. Use [◀ / ▶] to go back and forward between the hierarchies (only for JPEG files).
 - If you press [OK] on the desired file, playback will start.

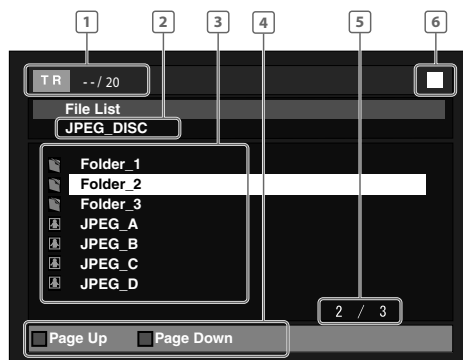

e.g.) JPEG

- 1 audio CD : Track information
JPEG : File information
- 2 audio CD : “CD-DA” will be displayed.
JPEG : Current Disc, SD Memory Card, or folder name will be displayed.
- 3 audio CD : List of the track number and time.
JPEG : List of the file / folder names in the current folder / disc
- 4 Operation: Press [RED] to go to the previous page.
guide Press [GREEN] to go to the next page.
- 5 Current page / Total page number
- 6 Playback status

Icons:



: Folder



: audio CD tracks



: JPEG files

- 3 Press [■ (stop)] to stop playback.

PLAYBACK

It is recommended that files to be played back in this unit are recorded under the following specifications:

<JPEG>

- Upper limit : 2,560 x 1,900 dots (sub sampling is 4:4:4)
5,120 x 3,840 dots (sub sampling is up to 4:2:2)
- Lower limit : 32 x 32 dots
- File size of image : 12 MB maximum

Note

- Do not delete the folders or files in the SD Memory Card with your computer. This unit may not read the SD Memory Cards formatted on a computer.
- With regard to the multi-border BD-RE/-R, additionally recorded sections cannot be recognized.
- With regard to the multi-border DVD-RW/-R, additionally recorded sections may not be recognized.

Kodak Picture CD

JPEG

This unit can also run JPEG files stored on Kodak Picture CD. You can enjoy picture images on the TV set by playing back the Kodak Picture CD. This unit conforms to ver.7.0 of Kodak Picture CD. For details of Kodak Picture CD, contact a shop that provides developing service of Kodak Inc.

1 When Kodak Picture CD is inserted in this unit, Kodak Picture CD menu will appear automatically on the TV screen.



- 1 File information
- 2 Current page / Total page number
- 3 Operation guide: Press [BLUE] to go to the previous page.
Press [YELLOW] to go to the next page.
- 4 Playback status

2 Use [▲ / ▼ / ◀ / ▶] to select a desired file to be played back, then press [▶ (play)] or [OK].

- An image will be played back from the selected file and go to the next one in turn.

3 Press [■ (stop)] to stop playback.

To return to the first item:
Press [TOP MENU].

To return to the file played last:
Press [POP MENU / MENU].

Tips for JPEG / Kodak Picture CD Playback

- Every press on [ANGLE] will turn the image clockwise by 90 degrees when an image is displayed.
- To change the visual effect for switching the playback image, press [MODE] once, then use [◀ / ▶] or [OK] to switch between "Cut In/Out" and "Fade In/Out".
- During JPEG / Kodak Picture CD playback, press [MODE] twice to change the size of the playback image, then use [◀ / ▶] or [OK] to switch between "Normal" (100%) and "Small" (95%). The size change may have no effect on some files (e.g. files with a small picture size).

Note

- Unrecognizable characters will be replaced with asterisks.
- Some unplayable folders or files may be listed due to the recording status.
- High-resolution JPEG files take longer to be displayed.
- Progressive JPEG files (JPEG files saved in progressive format) cannot be played back in this unit.
- The system can recognize up to 255 folders / 999 files for CD, 999 folders / 9,999 files for DVD and SD Memory Card.
- The 9th and deeper hierarchies cannot be displayed for CD. The 10th and deeper hierarchies cannot be displayed for DVD and SD Memory Card.
- For the SD Memory Card playback, refer to "Reading the SD Memory Card" on page 17.
- For an SD Memory Card, only an extension of ".jpg" can be recognized. For other media, only ".jpg" and ".jpeg" can be recognized, and any other extensions cannot be read.

PLAYBACK

Fast Forward / Fast Reverse



- 1 During playback, press **[▶▶ (forward)]** repeatedly for fast forward.
During playback, press **[◀◀ (reverse)]** repeatedly for fast reverse.
Every time you press **[▶▶ (forward)]** or **[◀◀ (reverse)]**, the playback speed will change.
- 2 Press **[▶ (play)]** to return to normal playback.

Note

- For BD, the approximate speed for the fast forward is 1 (1.3x), 2 (10x), 3 (30x), 4 (70x), and 5 (200x). And for the fast reverse, it is 1 (2x), 2 (10x), 3 (30x), 4 (70x), and 5 (200x).
- For DVD, the approximate speed for the fast forward or reverse playback is 1 (2x), 2 (8x), 3 (20x), 4 (50x), and 5 (100x).
- For audio CD, the approximate speed is 1 (2x), 2 (8x), and 3 (30x).
- For audio CD, fast forward / fast reverse search between different tracks are not available during program and random playback.

Slow Forward Playback



- 1 During playback, press **[|| (pause)]**, then press **[▶▶ (forward)]**.
Every time you press **[▶▶ (forward)]**, playback speed will change.
- 2 Press **[▶ (play)]** to return to normal playback.

Note

- The approximate speed for the slow forward playback is 1 (1/16x), 2 (1/8x), 3 (1/2x).
- Only slow forward is available.
- Set "Still Mode" setting to "Field" in "Video" menu if pictures in the slow forward playback mode are blurred. Refer to "Still Mode" on page 33.

Step by Step Playback



- 1 In pause mode, press **[|| (pause)]** repeatedly.
Every time you press **[|| (pause)]**, playback will advance one step at a time.
- 2 Press **[▶ (play)]** to return to normal playback.

Note

- Only step by step forward is available.
- Set "Still Mode" setting to "Field" in "Video" menu if pictures in step by step playback mode are blurred. Refer to "Still Mode" on page 33.

Repeat Playback

Available repeat functions vary depending the discs.

- 1 During playback, press **[REPEAT]** repeatedly to select the desired repeat mode.

Repeat mode	Available media
Chapter repeat The current chapter will be played back repeatedly.	
Title repeat The current title will be played back repeatedly.	
Track repeat The current track will be played back repeatedly.	
Group repeat The current folder will be played back repeatedly.	
All repeat All tracks or files in the media will be played back repeatedly.	

Note

- The repeat setting will be canceled when you stop playback.
- The chapter, title, track or group repeat will be cleared when moving to another chapter, title, track / file or folder.
- Chapter and title repeat are not available with some scenes.

Program Playback



You can play back the disc/card in your desired order.

1 In stop mode, press [MODE].

2 Use [▲ / ▼] to select a track / file, then press [OK].

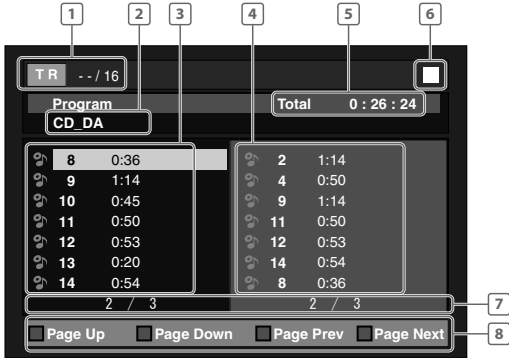

e.g.) audio CD

- 1** audio CD : Track information
JPEG : File information
- 2** audio CD : "CD-DA" will be displayed.
JPEG : Current Disc, SD Memory Card, or folder name will be displayed.
- 3** Track / File list : Track / File list in the original order.
- 4** Programmed list : Track / File list in the programmed order.
- 5** Cumulative playback time of all tracks / files in the programmed list.
- 6** Playback status
- 7** Current page / Total page number
- 8** Operation Guide: Press [RED] to go to the previous page in the track / file list.
Press [GREEN] to go to the next page in the track / file list.
Press [BLUE] to go to the previous page in the programmed list.
Press [YELLOW] to go to the next page in the programmed list.

- For JPEG files, use [▲ / ▼] to select a folder, then press [OK] first, and then use [▲ / ▼] to select a file, then press [OK].
- Press [CLEAR] to erase the last file of the program.
- Use [▲ / ▼] to select "All Clear" at the bottom of the list to erase all the tracks / files in the program.
- The programmed tracks / files is displayed in the right hand screen.
- Use [◀ / ▶] to go back / forward between the hierarchy of folders.

3 Press [▶ (play)] to start program playback.

- The program playback will start.

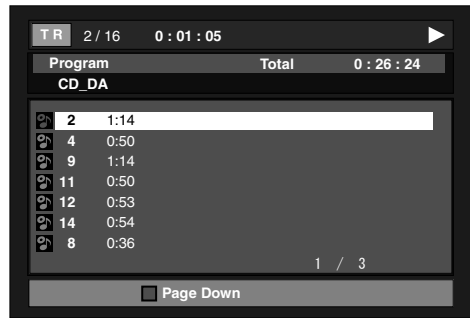

To exit from the program playback mode:

- Press [RETURN] in stop mode.

Note

- During program playback, press [■ (stop)] once to set the resume point, and then press [▶ (play)] to resume program playback from where [■ (stop)] was pressed (audio CD) or from beginning of the file where [■ (stop)] was pressed (JPEG).
- During program playback, press [■ (stop)] twice to display the program screen. To go back to the normal program playback, press [RETURN] to exit from the program screen, then press [▶ (play)].
- Up to 99 tracks / files can be entered.
- To repeat the current track / file in the program, press [REPEAT] repeatedly until "Track" appears during playback. To repeat the entire program, press [REPEAT] repeatedly until "All" appears during playback.
- Playback from a desired track / file and random playback are not available during program playback.
- Press [MODE] to switch to the random playback mode.
- The program will be cleared when;
 - the unit is turned into the standby mode.
 - the media mode is switched to the other mode.
 - the disc / card is removed. (as for "Disc" mode, just opening the disc tray will clear the program info.)

Random Playback



This function shuffles the playback order of tracks / files.

1 In stop mode, press [MODE] twice.

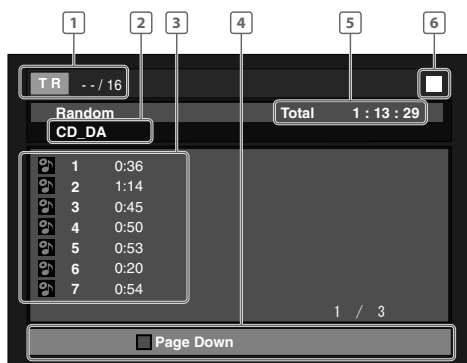

e.g.) audio CD

- 1 audio CD** : Track information
- JPEG** : File information
- 2 audio CD** : "CD-DA" will be displayed.
- JPEG** : Current Disc, SD Memory Card, or folder name will be displayed.
- 3 Track / File list** : Track / File list in the original order will be displayed.
- 4 Operation Guide** : Press [RED] to go to the previous page in the track / file list. Press [GREEN] to go to the next page in the track / file list.
- 5 Total playback time of all tracks / files.**
- 6 Playback status**

2 Press [▶] (play) to start random playback.

To exit from the random playback mode:

- Press [MODE] in stop mode.

Note

- During the random playback, press [■ (stop)] once to set the resume point, and then press [▶ (play)] to resume random playback from where [■ (stop)] was pressed (audio CD) or from beginning of the file where [■ (stop)] was pressed (JPEG).
- To repeat the current track / file in the random selection, press [REPEAT] repeatedly until "⏮ Track" appears during playback. To repeat the entire random selection press [REPEAT] repeatedly until "⏮ All" appears during playback.
- Playback from a desired track / file is not available during random playback.
- Press [RETURN] to switch to the program playback mode.

Rapid Playback



This function plays back approximately at 1.3 times the normal playback while keeping the sound output. This function is available only on discs recorded in the Dolby Digital format.

1 During playback, press [MODE] repeatedly until the Rapid playback setting appears.



2 Press [OK] or [◀ / ▶] to switch 1.3x, or off.

"Off" : Plays back in normal speed.

"1.3x" : Plays back approximately at 1.3 times of normal playback.

3 Press [▶] to return to normal playback.

Note

- Picture adjustment and audio language setting cannot be changed during this function.
- Virtual surround does not work during this function.
- This function may not work at some points on a disc.
- During this function, 2ch LPCM will be output from HDMI OUT jack and DIGITAL OUT jack.

Adjusting the Picture



You can adjust the picture quality.

1 During playback, press [MODE] repeatedly until [Picture icon] appears.

2 Use [▲ / ▼] to select your desired item, then use [◀ / ▶] to adjust the setting.



e.g.) DVD-video

■ Black level

You can adjust the black level setting to make the black parts of the pictures as bright as you prefer. You can select "On" or "Off".

"On" : Makes the dark parts brighter.

"Off" : Shows the original picture as recorded.

■ Noise reduction (DVD-video only)

Reduces the noise of the playback picture.

- “Off” : Shows the original picture as recorded.
- “1” : Executes 3D noise reduction which detects and deletes the noise by comparing each picture frames.
- “2” : Executes MPEG noise reduction which reduces the block noise and mosquito noise on the subtitle on movie.
- “3” : Executes both MPEG noise reduction and 3D noise reduction.

3 Press [RETURN] to exit.

Note

- The setting will remain the same even if the unit is turned to the standby mode.
- For the picture output from HDMI OUT jack, “Black Level” is not effective.
- You cannot adjust the setting during rapid playback.

Virtual Surround



You can enjoy stereophonic virtual space through your existing 2 channel stereo system.

- 1 During playback, press [MODE].
- 2 Use [▲ / ▼] to select your desired setting.



- “Off” : No surround effect
- “1” : Natural surround effect
- “2” : Stronger surround effect

3 Press [RETURN] to exit.

Note

- Set the virtual surround setting to “Off” or lower the volume if the sound is distorted.
- Virtual surround does not function during rapid playback.
- For the virtual surround, audio signal will always be 2-channel LPCM.

PIP (BONUSVIEW) Setting



Some BD-video have the PIP function which enables you to display the secondary video in the primary video. You can call up the secondary video by pressing [MODE] whenever the scene contains the secondary video.

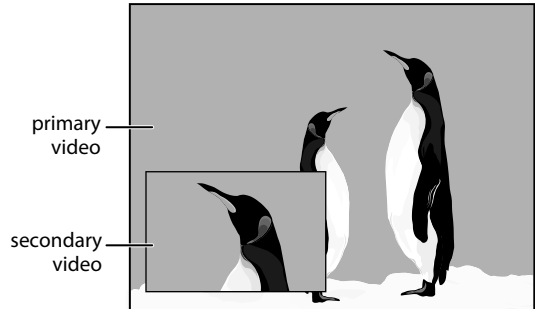

- 1 During playback, press [MODE] repeatedly until the PIP function appears.
- 2 Use [▲ / ▼] to select the secondary video you want.
 - The secondary video will be displayed and the secondary audio will be output.
- 3 Press [RETURN] or [MODE] to remove the PIP information.

Note

- The secondary audio will not be output when the secondary audio is set to “Off” or when “BD Audio Mode” is set to “HD Audio Output”. Refer to “Switching Audio Soundtrack” on page 27 and “Setting the BD Audio Mode” on page 28.

Camera Angle



Some BD-video and DVD-video contain scenes which have been shot simultaneously from various angles. You can change the camera angle when  appears on the TV screen.

- 1 During playback, press [ANGLE].
 - The selected angle will be displayed on the display bar at the top of the TV screen.
- 2 Use [▲ / ▼] to select your desired angle.



Note

- If “Angle Icon” setting is “Off” in “Others” menu,  will not appear. Refer to page 40.

PLAYBACK

Search

Using [◀◀ / ▶▶] (skip)

1 During playback, press [▶▶] (skip) to move to the next track / title / chapter / file. Press it repeatedly to skip to subsequent tracks. Press [◀◀] (skip) once to go back to the beginning of the current track. Press it repeatedly to go to the previous tracks.













- For JPEG files, press [◀◀] (skip) to go back to the previous file.

Note

- For BD and DVD, if title contains no chapters, [◀◀ / ▶▶] (skip) changes the title.
- For JPEG files, [◀ / ▶] is also available.

Using [SEARCH]

By using [SEARCH], you can select the following search modes.

Search mode	Available media
 /  Chapter / Title search	 
  Track search	 
 Time search	  

1 During playback, press [SEARCH] repeatedly until your desired search mode appears.

2 Enter the desired chapter, title, track, file number or time to search for using [Number buttons].

- Chapter, title, track or time search will start.
- Press [CLEAR] to erase an incorrect input.

Note

- During program and random playback, search functions are not available except the search using [◀◀ / ▶▶] (skip).
- Time search is available only in the same track, file or title.
- For BD, chapter and time search are available only during playback.

Using [Number buttons] (Direct Search)

Title Search

1) In stop mode, enter the title number you want to search using [Number buttons].

Playback of the title will start in a few seconds.

Chapter Search

1) During playback of a title, enter the chapter number you want to search using [Number buttons].

Playback of the chapter will start in a few seconds.

Note

- As for the BD-video, how it performs will be strongly determined by the disc, and may not perform as described here.

You can select the format of audio and video as you prefer depending on the contents of the disc you are playing back.

Switching Subtitles

Some BD and DVD may have subtitles in 1 or more languages. For commercially available discs, the supported languages can be found on the disc case. Follow the steps below to switch the subtitle languages during playback.



- 1 During playback, press [SUBTITLE].
- 2 Use [▲ / ▼] to select "Primary Subtitle", "Secondary Subtitle" or "Subtitle Style", then press [OK].

	Primary Subtitle	2 ENG/11
	Secondary Subtitle	2 ENG/11
	Subtitle Style	2/25

- "Primary Subtitle" : Sets the subtitle for the primary video.
- "Secondary Subtitle" : Sets the subtitle for the secondary video.
- "Subtitle Style" : Sets style of the subtitle.

- 3 Use [▲ / ▼] to select your desired subtitle or style.

- Use [◀ / ▶] to switch between current subtitle setting and "Off".

- 4 Press [SUBTITLE] to exit.



- 1 During playback, press [SUBTITLE].
- 2 Use [▲ / ▼] to select your desired subtitle.



- Use [◀ / ▶] to switch between current subtitle setting and "Off".

- 3 Press [SUBTITLE] to exit.

Note

- Some discs will only allow you to change the subtitles from the disc menu or pop-up menu. Press [TOP MENU] or [POP MENU / MENU] to display the disc menu or pop-up menu.
- If 4-digit-language code appears in the subtitle menu, refer to "Language Code List" on page 47.
- If the disc has no subtitle language or subtitle style, "Not Available" will be displayed on the TV screen.
- During playback of the secondary video, the primary subtitle setting is not available except when there is no subtitle for the secondary video.
- If you select a language that has a 3-letter-language code, the code will be displayed every time you change the subtitle language setting. If you select any other languages, "---" will be displayed instead. (Refer to page 47.)

Switching Audio Soundtrack

Some BD and DVD contain multiple audio streams. Those are often in different audio languages or audio formats. For BD, available audio varies depending on "BD Audio Mode" setting. Refer to page 34 for more information.



- 1 During playback, press [AUDIO].
- 2 Use [▲ / ▼] to select "Primary" or "Secondary" audio to set, then press [OK].

	Primary				
1	ENG	Dolby D	Multi-ch	/3	
	Secondary				
2	ENG	Dolby D+	Multi-ch	/3	

- "Primary" : Sets the audio for the primary video.
- "Secondary" : Sets the audio for the secondary video.

- 3 Use [▲ / ▼] to select your desired audio stream channel.

- For "Secondary", use [◀ / ▶] to switch between current audio setting and "Off".

- 4 Press [AUDIO] to exit.



- 1 During playback, press [AUDIO].
- 2 Use [▲ / ▼] to select your desired audio stream channel.

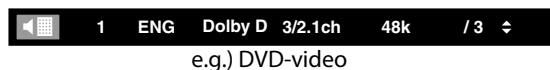

e.g.) DVD-video

- For audio CD, you can select following options.

- "Stereo" : Both right and left channels are active (stereo).
- "L-ch" : Only left channel is active.
- "R-ch" : Only right channel is active.

- 3 Press [AUDIO] to exit.

Note

- The secondary audio will not be output when the secondary video is not displayed or when "BD Audio Mode" is set to "HD Audio Output". (For some BD, secondary audio will be output even when secondary video is off.)
- The sound mode cannot be changed during playback of discs not recorded in multiple audio.
- Some discs allow changing the audio language setting on the disc menu. (Operation varies depending on the discs. Refer to the manual accompanying the disc.)
- **[AUDIO]** may not work on some discs with multiple audio streams or channels (e.g. DVDs that allow changing audio setting on the disc menu).
- If you select a language that has a 3-letter-language code, the code will be displayed every time you change the audio language setting. If you select any other languages, "---" will be displayed instead. (Refer to page 47.)
- Audio Language selection cannot be made during rapid playback. (Refer to page 24.)
- If 4-digit-language code appears in the audio menu, refer to page 47.
- If the disc has no audio language, "Not Available" will be displayed on the TV screen.
- For DTS-CD (5.1 music disc), selecting audio streams or channels is not available.

Setting the BD Audio Mode



There are 2 options for the "BD Audio Mode" setting; either by setting the output to the secondary and interactive audio accompanied by the primary audio or by setting only the primary audio. Depending on the setting of the mode, Dolby Digital, Dolby Digital Plus, Dolby TrueHD, DTS, or DTS-HD output changes between multi LPCM and bitstream.

- 1 In stop mode with BD inserted, press [MODE].**
- 2 Use [▲ / ▼] to select your desired setting.**



"Mix Audio Output":

If it is available, BD-video's secondary and interactive audio will be output with the primary audio.

- The secondary audio is the audio for the secondary video (Director's comment etc.) and the interactive audio is the audio for the interactive application (Button click sounds etc.).

"HD Audio Output":

Only the primary audio will be output. Set this mode in order to output , Dolby Digital Plus, Dolby TrueHD, or DTS-HD audio of BD through HDMI connection.

- 3 Press [RETURN] to exit.**

- You can also set "BD Audio Mode" from the setup menu. Refer to page 34.
- Refer to "Audio signals output from HDMI OUT jack" on page 35 and "Audio signals output from DIGITAL OUT (COAXIAL) jack" on page 36 for how BD Audio will be output.

Note

- In "Mix Audio Output" mode, if there is no secondary and interactive audio, the audio will be output as "HD Audio Output" mode.

FUNCTION SETUP

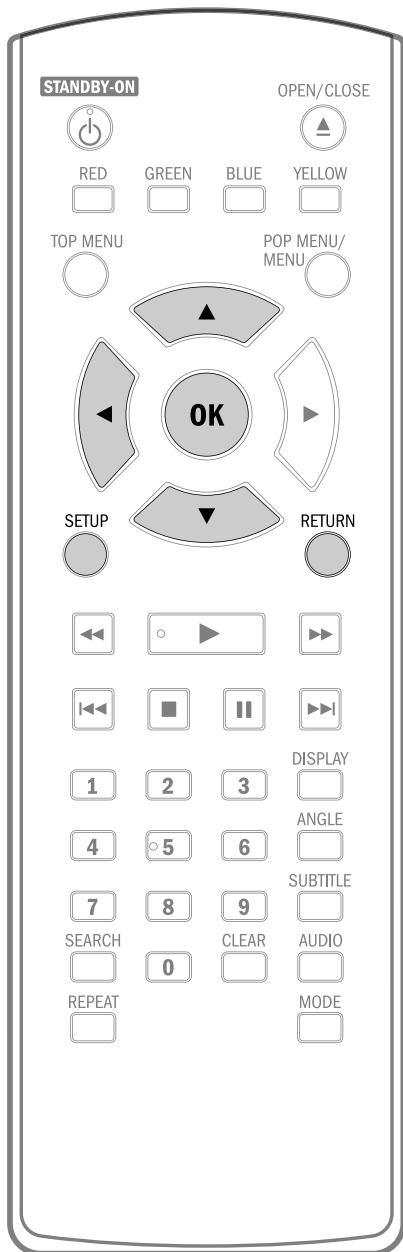



Using the Setup Menu

In the setup menu you can change the setting for audio, video, language, etc. You cannot change the setting during playback.

Setting items displayed in gray indicates they are not available under the conditions at the time.

Quick

" Quick" menu contains setting items extracted from " Custom" menu which may be used frequently.

1 In stop mode, press [SETUP].

2 Use [▲ / ▼] to select , then press [OK].

3 Use [▲ / ▼] to select your desired setting items.

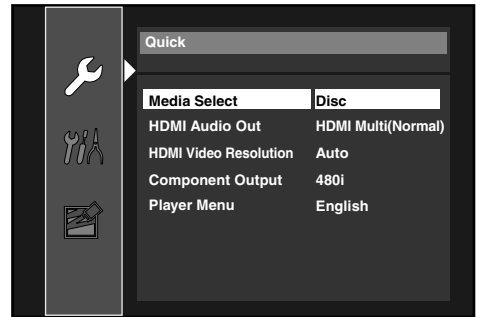

4 Follow the procedure below depending on the setting items.

- A) If "▶" does not appear on the right side of the setting items when you select the items:
Press [OK] repeatedly to change options.
- B) If "▶" appears on the right side of the setting items when you select the items:
1) Press [OK].
2) Use [▲ / ▼] to select options, then press [OK].
• Use [◀] or [RETURN] to go back to the previous screen.





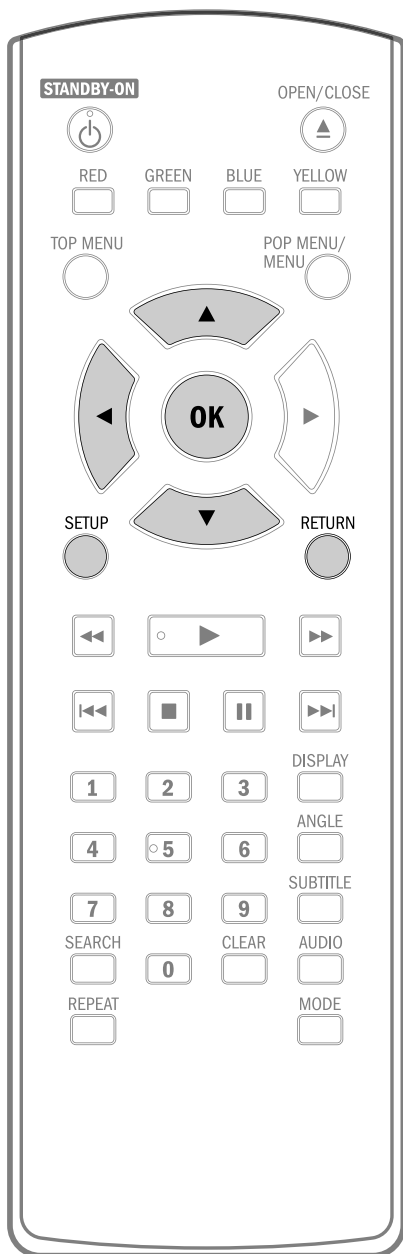

5 Press [SETUP] to exit.

FUNCTION SETUP



Custom

" Custom" menu contains all the setting items.

- 1** In stop mode, press [SETUP].
- 2** Use [▲ / ▼] to select , then press [OK].
- 3** Use [▲ / ▼] to select your desired setting category, then press [OK].
 -  Language
 -  Video
 -  Audio
 -  Parental
 -  Others
 - For "Parental" menu, follow the procedure on page 39.
- 4** Use [▲ / ▼] to select your desired setting items.
- 5** Follow the procedure below depending on the setting items.
 - A) If "▶" does not appear on the right side of the setting items when you select the items:
Press [OK] repeatedly to change options.
 - B) If "▶" appears on the right side of the setting items when you select the items:
 - 1) Press [OK].
 - 2) Use [▲ / ▼] to select options, then press [OK].
 - Use [◀] or [RETURN] to go back to the previous screen.
- 6** Press [SETUP] to exit.

Language



- To select the setting items and options, refer to “ Custom” on page 30.
- “ Quick” menu consists of the setting menus frequently used, and they are accompanied with .

Setting items	Options
Audio Sets the language for audio.	Original* / English / French / Spanish / German / Italian / Swedish / Dutch / Russian / Chinese / Japanese / Korean / Danish / Finnish / Norwegian / Icelandic / Hungarian / Romanian / Turkish / Greek / Irish / Portuguese / Polish / Czech / Slovak / Bulgarian / Other
Subtitle Sets the language for subtitle.	Off* / English / French / Spanish / German / Italian / Swedish / Dutch / Russian / Chinese / Japanese / Korean / Danish / Finnish / Norwegian / Icelandic / Hungarian / Romanian / Turkish / Greek / Irish / Portuguese / Polish / Czech / Slovak / Bulgarian / Other
Disc Menu Sets the language for disc menu or pop-up menu.	English* / French / Spanish / German / Italian / Swedish / Dutch / Russian / Chinese / Japanese / Korean / Danish / Finnish / Norwegian / Icelandic / Hungarian / Romanian / Turkish / Greek / Irish / Portuguese / Polish / Czech / Slovak / Bulgarian / Other
Player Menu Sets the language for OSD (on-screen display).	Auto(XXXX) ^{*1} / English* / Français / Español

)Settings with () are the default.

*1) “Auto” activates the Get & Set Menu Language function. Refer to page 41.

- “Auto” is available only when “HDMI CEC” is set to “On”.

- inside the parentheses next to “Auto” will be the language which is currently selected by your TV.

- For “Audio”, “Subtitle”, and “Disc Menu”, if you select “Other”, enter the 4-digit-number code for the desired language. (Refer to “Language Code List” on page 47.) Only the languages supported by the disc can be selected.

FUNCTION SETUP

Video

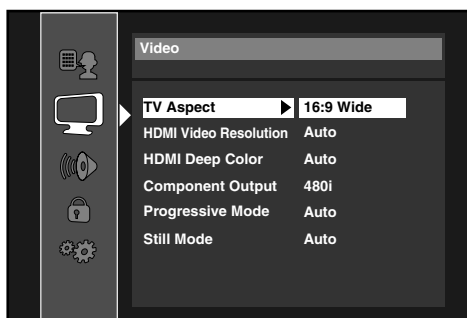

- To select the setting items and options, refer to “ Custom” on page 30.
- “ Quick” menu consists of the setting menus frequently used, and they are accompanied with .

Setting items	Options
TV Aspect Sets the picture size according to aspect ratio of the connected TV.	16:9 Wide*: Select this when a wide-screen TV is connected. Discs recorded in wide-screen format is played back over the entire TV screen. 4:3 Pan & Scan: Select this to play back the discs recorded in wide-screen format with 4:3 TV in the pan & scan mode (with the sides of the picture cut off). Discs which are not specified for pan & scan are played back in the letter box mode. 4:3 Letter Box: Select this to play back the discs recorded in wide-screen format with 4:3 TV in the letter box mode. (with black strips at the top and bottom.) 16:9 Squeeze: When playing back 4:3 images, the picture is displayed in the center of the 16:9 screen with a 4:3 aspect ratio.
HDMI Video Resolution Sets the HDMI video resolution.	Auto*: HDMI video resolution will be selected automatically depending on the connected HDMI device. 480p
HDMI Deep Color Sets whether to output the picture from HDMI OUT jack with Deep Color or not.	Auto*: The picture from HDMI OUT jack will be output with Deep Color to the connected TV which supports HDMI Deep Color. Off: The picture from HDMI OUT jack will be output without Deep Color.
Component Output Sets the video resolution for component output.	480i* 480p 720p 1080i
Progressive Mode Sets the optimum progressive mode for the image material output from HDMI OUT jack and COMPONENT VIDEO OUT jacks.	Auto*: The progressive mode will detect 24-frame film material (movies) and automatically select appropriate progressive mode. Video: Suited for playing back video material discs (TV shows or animation).

FUNCTION SETUP

Setting items	Options
Still Mode*1 Adjusts picture resolution and quality in still mode.	Auto*: Automatically selects the best resolution setting ("Frame" or "Field") based on the data characteristics of the pictures.
	Field: Stabilizes the pictures, although the picture quality may become coarse due to the limited amount of data. Select "Field" when the pictures are still unstable even if "Auto" is selected.
	Frame: Displays relatively motionless pictures in higher resolution. "Frame" improves the picture quality, although it may unstabilize the pictures due to alternate output of 2-field data.

)Settings with () are the default.

*1) An individual picture on the TV screen is called "Frame", which consists of two separate images called "Field". Some pictures may be blurred at the auto setting in "Still Mode" setting due to their data characteristics.

Note for "HDMI Video Resolution" and "Component Output"

- Even if you set "HDMI Video Resolution" setting to "Auto", when this unit is connected to a DVI compatible display devices with an HDMI-DVI cable, 480p signal will be output.
- Video and audio signals may be distorted temporarily when switching to / from the HDMI output mode.
- You cannot change the video resolution during Blu-ray Disc playback. To change the resolution, stop playback.
- In order to get natural and high quality film reproduction of 24-frame film material, use an HDMI cable (High Speed HDMI Cable is recommended) and select "Auto" if the connected TV is compatible with 1080p24 frame input.
- Even if the connected TV is compatible with 1080p24 frame input and you set "HDMI Video Resolution" setting to "Auto", when the contents of the disc are not compatible for 1080p24 frame, 1080p60 frame will be output.
- If the picture is not output properly to the TV because of "HDMI Video Resolution" or "Component Output" setting, press and hold [▶ PLAY] on the front panel for more than 5 seconds. Both settings will be reset to the default automatically.
- For video resolution of the component output, you can only select the video resolution which is currently output from HDMI OUT jack or "480i" if HDMI cable is connected.
- If the video resolution for the component output and HDMI video resolution do not match, the video resolution for the component output will be switched to "480i".
- If you play back copy-protected DVD-video, 480p signal will be output from COMPONENT VIDEO OUT jacks, when "Component Output" setting is set to "720p" or "1080i".

FUNCTION SETUP

Audio

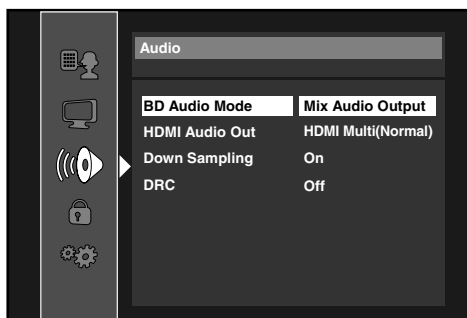

- To select the setting items and options, refer to “ Custom” on page 30.
- “ Quick” menu consists of the setting menus frequently used, and they are accompanied with .

Setting items	Options
BD Audio Mode For BD, selects whether to output the secondary and interactive audio with primary audio if it is available or only the primary audio. Refer to “Setting the BD Audio Mode” on page 28.	Mix Audio Output*: Outputs the secondary and interactive audio with primary audio if it is available. HD Audio Output: Outputs only the primary audio. Set this mode in order to output Dolby Digital, Dolby Digital Plus, Dolby TrueHD, DTS or DTS-HD audio of BD through HDMI connection.
HDMI Audio Out Sets the audio format for the audio output from HDMI OUT jack. Refer to page 35.	HDMI Multi(Normal)*: The multi-channel audio signals are output from HDMI OUT jack with bitstream or LPCM. HDMI Multi(LPCM): The multi-channel audio signals are output from HDMI OUT jack with LPCM. Refer to pages 37-38 for setting options. Audio Mute: Mutes the HDMI audio signal, and set the signal format from DIGITAL OUT jack. Refer to “Digital Out setting” on page 36 for setting options.
Down Sampling Sets the digital audio output when playing back BD or DVD recorded in LPCM.	On*: LPCM signals are converted to 48 kHz for output. Set to “On” when using digital connections to an AV amplifier that is not compatible with sampling frequencies of 96 kHz. Off: For BD and DVD recorded in LPCM without copyright protection, 2-channel audio signals up to 192 kHz are output as LPCM signals with no conversion.
DRC Sets whether to compress the range of sound volume (dynamic range control) when Dolby Digital, Dolby Digital Plus or Dolby TrueHD audio is played back.	On Off*

)Settings with () are the default.

- Under following circumstances, “HDMI Multi(Normal)” and “HDMI Multi(LPCM)” are not available.
 - HDMI cable is not connected to HDMI OUT jack.
 - Connected TV is off.
 - Connected TV is not compatible with audio output.

FUNCTION SETUP

HDMI Audio Out Setting

When using HDMI connections make "HDMI Audio Out" setting in "Audio" menu according to the specifications of the device to be connected. Refer to page 34. Normally, set it to "HDMI Multi(Normal)" so that the unit automatically picks and outputs the best audio format suited to your connected device.

Device to be connected	"HDMI Audio Out" setting	Output HDMI audio signal
Device compatible with Dolby Digital, Dolby Digital Plus, Dolby TrueHD, DTS or DTS-HD decoding	HDMI Multi(Normal)	Dolby Digital, Dolby Digital Plus, Dolby TrueHD, DTS, or DTS-HD bitstream are output from HDMI OUT jack. Make the speaker settings on the connected AV amplifier, etc.
Device compatible with 3 or more channels of audio inputs (not Dolby Digital, Dolby Digital Plus, Dolby TrueHD, DTS or DTS-HD compatible)	HDMI Multi(LPCM)	Multi-channel audio signals are output from HDMI OUT jack. Make the speaker settings with the speaker setting items appear after you select "HDMI Multi(LPCM)". Refer to page 34.
HDMI connection to a TV and digital audio connection (coaxial) to an AV amplifier.	Audio Mute	HDMI audio will be mute, and Dolby Digital / DTS bitstream or LPCM will be output from DIGITAL OUT jack depending on "Digital Out setting". Refer to page 36.

Audio signals output from HDMI OUT jack

Media	Recording format	"HDMI Audio Out" setting			
		HDMI Multi(Normal)		HDMI Multi(LPCM)	
		When "BD Audio Mode" is set to "HD Audio Output"	When "BD Audio Mode" is set to "Mix Audio Output"	When "BD Audio Mode" is set to "HD Audio Output"	When "BD Audio Mode" is set to "Mix Audio Output"
BD-video	Dolby Digital	Dolby Digital	Dolby Digital	Multi LPCM	Multi LPCM
	Dolby Digital Plus	Dolby Digital Plus	Dolby Digital	Multi LPCM ^{*1}	Multi LPCM ^{*1}
	Dolby TrueHD	Dolby TrueHD	Dolby Digital	Multi LPCM ^{*2}	Multi LPCM ^{*2}
	DTS	DTS	DTS	Multi LPCM	Multi LPCM
	DTS-HD	DTS-HD	DTS	Multi LPCM ^{*3}	Multi LPCM ^{*3}
	LPCM	Multi LPCM	Multi LPCM	Multi LPCM	Multi LPCM
DVD-video	Dolby Digital	Dolby Digital		Multi LPCM	
	DTS	DTS		Multi LPCM	
	LPCM	2ch LPCM		2ch LPCM	
audio CD	2ch LPCM		2ch LPCM		
DTS-CD	DTS		Multi LPCM		

*1) Outputs audio signals decoded from independent substream.

*2) Outputs audio signals decoded from Dolby Digital stream.

*3) Outputs audio signals decoded from DTS core stream.

- If the connected device is not compatible with the HDMI BITSTREAM, audio will be output as multi LPCM or 2-channel down-mixed LPCM depending on the capability of the connected device even if you select "HDMI Multi(Normal)" in "HDMI Audio Out" setting.

Note

- The audio signals from HDMI OUT jack (including the sampling frequency, the number of channels and bit length) maybe limited by the device that is connected.
- Among the devices that support HDMI, some do not support audio output (e.g. projectors). In connections with device such as this unit, audio signals are not output from HDMI OUT jack.
- Video and audio signals may be distorted temporarily when switching to / from the HDMI output mode.

FUNCTION SETUP

Digital Out setting

When "Audio Mute" is selected in "HDMI Audio Out" setting, HDMI audio signal will be mute and the audio signals output from DIGITAL OUT jack changes depending on "Digital Out" setting.

Quick → HDMI Audio Out → Audio Mute → Digital Out

Bitstream* :

When playing back discs recorded in Dolby Digital, Dolby Digital Plus, Dolby TrueHD, DTS or DTS-HD, the corresponding core stream (Dolby Digital or DTS) are output.

LPCM :

LPCM signal will be output from DIGITAL OUT jack.

- This setting is not effective when the HDMI audio signal is output.

Audio signals output from DIGITAL OUT (COAXIAL) jack

For the settings in the "Digital Out" to take effect, "HDMI Audio Out" should be set to "Audio Mute". Otherwise, the settings made in the "HDMI Audio Out" will have a priority, and the same signal as being output from the HDMI OUT jack will be output from the DIGITAL OUT jack as well. (Except that Dolby Digital will be output instead of Dolby Digital Plus and Dolby TrueHD, and DTS signal will be output instead of DTS-HD.)

Media	Recording format	"Digital Out" setting			
		Bitstream		LPCM	
		When "BD Audio Mode" is set to "HD Audio Output"	When "BD Audio Mode" is set to "Mix Audio Output"	When "BD Audio Mode" is set to "HD Audio Output"	When "BD Audio Mode" is set to "Mix Audio Output"
BD-video	Dolby Digital	Dolby Digital	Dolby Digital	2ch Downmix LPCM	2ch Downmix LPCM
	Dolby Digital Plus	Dolby Digital	Dolby Digital	2ch Downmix LPCM ^{*1}	2ch Downmix LPCM ^{*1}
	Dolby TrueHD	Dolby Digital	Dolby Digital	2ch Downmix LPCM ^{*2}	2ch Downmix LPCM ^{*2}
	DTS	DTS	DTS	2ch Downmix LPCM	2ch Downmix LPCM
	DTS-HD	DTS	DTS	2ch Downmix LPCM ^{*3}	2ch Downmix LPCM ^{*3}
	LPCM	2ch Downmix LPCM	2ch Downmix LPCM	2ch Downmix LPCM	2ch Downmix LPCM
DVD-video	Dolby Digital	Dolby Digital		2ch Downmix LPCM	
	DTS	DTS		2ch Downmix LPCM	
	LPCM	2ch LPCM		2ch LPCM	
audio CD	2ch LPCM		2ch LPCM		
DTS-CD	DTS		2ch Downmix LPCM		

*1) Only the independent substream is decoded.

*2) Only the Dolby Digital substream is decoded.

*3) Only the core substream is decoded.

Note

- In order to output LPCM signal from DIGITAL OUT jack while outputting the HDMI audio signal, set "HDMI Audio Out" setting to "HDMI Multi(LPCM)".

FUNCTION SETUP

Speaker setting (Available when you have HDMI cable connected to HDMI OUT jack)

This unit allows you to enjoy multi-channel surround sound such as 7.1-channel / 5.1-channel surround. To make the most of its feature, set up your speakers appropriately by referring to the following table.

How to navigate through "HDMI Multi(LPCM)":

- 1) Use [▲ / ▼] to select your desired menu item then press [OK].
- 2) Use [▲ / ▼] to select your setting items.
 - Press [RETURN] to go back to the previous screen.
- 3) Use [◀ / ▶] to select desired options. (Except for "Test Tone", "Default" and setting options in "Speaker Size" setting.)

For setting options in "Speaker Size" setting:
Press [OK] to select desired options.

For "Test Tone":

Use [◀ / ▶] to select "Off", "Manual" or "Auto", then press [OK].

- The test tone will be output. If you select "Manual", use [▲ / ▼] to select desired speaker, then use [◀ / ▶] to adjust the volume. If you select "Auto", use [◀ / ▶] to adjust the volume of the speaker that outputs the test tone.
- If you want to stop the test tone, press [RETURN].

For "Default":

Press [OK] to reset to the default.

- 4) Press [SETUP] to exit.

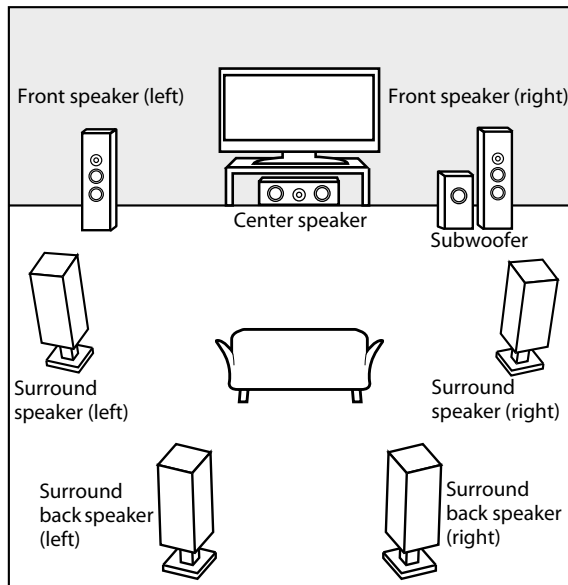

e.g.) basic layout with 7.1-channel surround system

<Speaker setting for the audio signal output from HDMI OUT jack>

Quick → HDMI Audio Out → HDMI Multi(LPCM)			
Custom → Audio → HDMI Audio Out → HDMI Multi(LPCM)			
Menu	Setting items	Options	Descriptions
Speaker Size Selects the desired speaker to set. Then change the setting by referring to the descriptions.	Front	Large*	Large: For the large speakers with strong low frequency reproduction capabilities.
		Small	
	Center	Large*	Small: For the small speakers which do not provide strong bass sound.
	Small		
	Subwoofer	On	You cannot change the setting of "Subwoofer".
	Surround	Large*	
		Small	
Surround Back	Large*	Speakers which are not supported by the connected device will be displayed in gray.	
	Small		
Default		Select "Default", then press [OK] to reset "Speaker Size" setting to the default.	

FUNCTION SETUP

Menu	Setting items	Options	Descriptions
Channel Level Tests or sets the volume for each speaker.	Test Tone: "Test Tone" is the test tone which can be output from the speakers so you can adjust the volume for each speaker.	Off*	Select "Off" to deactivate "Test Tone". Select "Manual", then press [OK] to manually set the volume for the desired speaker. Select "Auto", then press [OK] to automatically output the test tone from each speaker.
		Manual	
		Auto	
	Front Lch	0dB to -12dB (0dB*)	If you have selected "Manual" in "Test Tone", select the desired speaker to set and adjust the volume for the selected speaker. If you select "Auto" in "Test Tone", test tone will automatically be output in order. Adjust the volume of the speaker that outputs the test tone.
	Center	0dB to -12dB (0dB*)	
	Subwoofer	0dB to -12dB (0dB*)	
	Front Rch	0dB to -12dB (0dB*)	
	Surround Rch	0dB to -12dB (0dB*)	
	Surround Back Rch	0dB to -12dB (0dB*)	
	Surround Back Lch	0dB to -12dB (0dB*)	
Surround Lch	0dB to -12dB (0dB*)		
Default		Select "Default", then press [OK] to reset "Channel Level" setting to the default.	
Delay Time This is a parameter for optimizing the timing at which the sound outputs from the speakers according to the distance from the listening position.	Distance	Feet*	Set the desired measure system. This measure system will be used for "Delay Time" setting. Press [OK] to switch the settings.
		Meters	
	Front	0ft to 60ft (12ft*) (0 m to 18 m (3.6 m*))	Select the distance from the listening position to the speaker to get the ideal delay time.
	Center	0ft to 60ft (12ft*) (0 m to 18 m (3.6 m*))	
	Surround	0ft to 60ft (10ft*) (0 m to 18 m (3.0 m*))	
	Surround Back	0ft to 60ft (10ft*) (0 m to 18 m (3.0 m*))	
	Default		Select "Default", then press [OK] to reset "Delay Time" setting to the default.

)Settings with () are the default.

- For "Speaker Size" setting, the settings of each speaker size may be adjusted automatically corresponding to each setting. (e.g. If "Front" is set to "Small", you cannot set "Center", "Surround", and "Surround Back" to "Large".)
- For "Delay Time", the difference between the value of the "Front", "Surround" and "Surround Back" setting cannot exceed 15 ft (4.5m), and the difference between the value of the "Front" and "Center" setting cannot exceed 5 ft (1.5m).
- For "Delay Time", the value of the "Center", "Surround" and "Surround Back" setting cannot exceed the value of the "Front" setting.
- For "Delay Time", the setting of "Center", "Surround" and "Surround Back" will be changed automatically to the setting value of the "Front". (e.g. If the "Front" is set to 60ft (18m), the setting of "Center", "Surround" and "Surround Back" will be changed to 60ft (18m) as well.)

■ Parental

Ratings control allows you to set a limit, which prevents your children from viewing inappropriate materials. Playback will be stopped if the ratings exceed the levels you set, and it will require you to enter a password before playing back the disc.

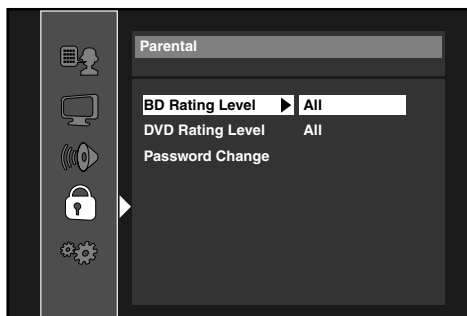

1 Use [**▲** / **▼**] to select , then press [OK].

2 Use [Number buttons] to enter your 4-digit password.

For the first time use: Use [Number buttons] to enter any 4-digit number (except for 4737), then press [OK]. That number will be used as the password from the second time. Record your password in case you forget it.

- If you forget the password, enter [4], [7], [3], [7]. The password will be cleared and rating level will be set to "All".
- While you input the password, press [CLEAR] to clear the number, then re-enter the password.

3 Proceed to A – C

A) BD Rating Level

1) Use [**▲** / **▼**] to select "BD Rating Level", then press [OK].

2) Use [**▲** / **▼**] to select your desired option, then press [OK].

"All": To release the limitation.

"Age Setting": To set the age limitation.

- After selecting "Age Setting", use [Number buttons] to enter the age from 0 – 254.
(e.g. for age 15, press [0], [1], [5])

3) Press [SETUP] to exit.

B) DVD Rating Level

1) Use [**▲** / **▼**] to select "DVD Rating Level", then press [OK].

2) Use [**▲** / **▼**] to select your desired level, then press [OK].

3) Press [SETUP] to exit.

RATING EXPLANATIONS

- **All** : Parental Control is inactive; all discs can played back.
- **8 [Adult]** : DVD software of any grades (adult / general / children) can be played back.
- **7 [NC-17]** : No one under 18 admitted.
- **6 [R]** : Restricted; under 18 requires accompanying parent or adult guardian.
- **5 [PGR]** : Parental guidance recommended.
- **4 [PG-13]** : Unsuitable for children under 13.
- **3 [PG]** : Parental guidance suggested.
- **2 [G]** : General audience.
- **1 [Kid Safe]** : Suitable for children.

C) Password Change

1) Use [**▲** / **▼**] to select "Password Change", then press [OK].

2) Enter a new 4-digit password, then press [OK].

3) Press [SETUP] to exit.

FUNCTION SETUP

Others

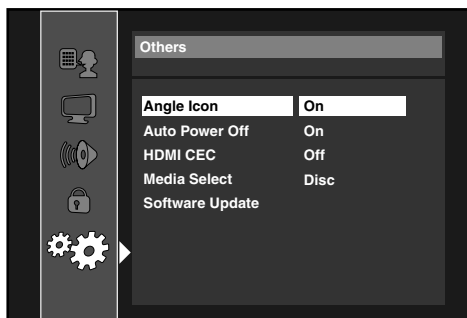

- To select the setting items and options, refer to “ Custom” on page 30.
- “ Quick” menu consists of the setting menus frequently used, and they are accompanied with .

Setting items	Options
Angle Icon	On*: The angle icon appears on the TV screen when playing back the scene with various angle. Off: The angle icon disappears on the TV screen.
Auto Power Off	On*: If this unit is left with no activity for more than 30 minutes, this unit turns off automatically. Off: Sets off the auto power off.
HDMI CEC Sets whether to utilize the HDMI CEC function. Refer to page 41.	On Off*
Media Select Selects the media to playback.	Disc*: Select this when you play back a disc. SD Card: Select this when you play back an SD Memory Card.
Software Update Allows you to update this unit's firmware. Refer to page 42.	Current Version: Indicates the current firmware version. Disc Update: Allows you to update this unit's firmware using a disc.
	No* Yes

■ HDMI CEC

HDMI CEC allows integrated system control over HDMI and is part of the HDMI standard. This function may not work properly depending on a device to be connected. When "HDMI CEC" setting is set to "On", functions listed below will be available.

One Touch Play

When this unit is turned on, the TV also is turned on and the appropriate external input channel will be selected automatically. The appropriate external input channel can also be selected on your TV automatically when you press **[▶ (play)]**, **[⏮ (skip)]**, **[▶⏭ (skip)]**, **[Number buttons]**, **[DISPLAY]**, **[TOP MENU]**, or **[POP MENU / MENU]** when the unit's power is on. (Buttons other than **[▶ (play)]** works only with discs inserted.)

Standby

When you press and hold **[STANDBY-ON ⏻]** for 2 seconds, it turns off the power of the TV first and then turns off the power of this unit also.

When the connected HDMI CEC compatible display device is turned off, this unit may also turn off together.

System Information

Get & Set Menu Language

The unit recognizes the OSD language set for the TV and automatically sets the same language as the player menu language (OSD menu language) for this unit.

- This feature is available only when "Auto(XXXX)" is selected in "Player Menu" in the setup menu. (Refer to "Player Menu" on page 31.)

■ Current Version

You can confirm the current software version.

1 Use [▲ / ▼] to select , then press [OK].

2 Use [▲ / ▼] to select "Software Update", then press [OK].

3 Use [▲ / ▼] to select "Current Version", then press [OK].



4 Press [OK] or [RETURN] to exit.

Note

- Please visit www.magnavox.com to download the latest firmware version.

■ Software Update

This unit lets you update the firmware yourself using a firmware update disc.

To update the firmware, you must first download the latest firmware to a disc, then execute "Software Update".

1 Prepare a firmware update disc:

Please access www.magnavox.com, and download the latest firmware to a blank disc by following the direction described on the site.

- Use a blank disc and download one firmware per disc.
- For more details on how to download the firmware, please refer to the site.

2 Use [▲ / ▼] to select , then press [OK].

3 Use [▲ / ▼] to select "Software Update", then press [OK].

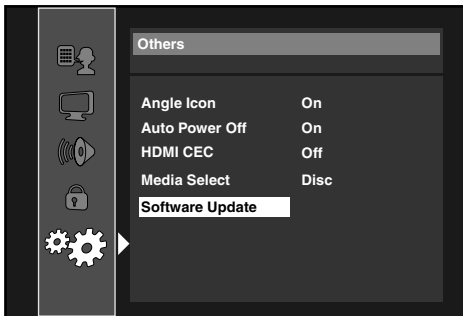

4 Use [▲ / ▼] to select "Disc Update", then press [OK].

- Confirmation message will appear.

5 Use [▲ / ▼] to select "Yes", then press [OK].

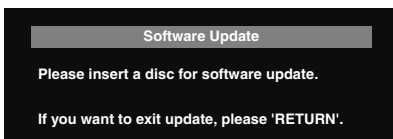
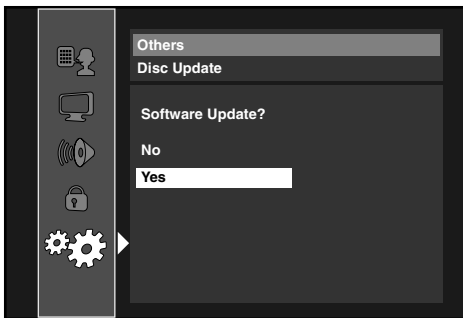

- Disc tray will open automatically.

6 Insert the firmware update disc created at step 1.

- When the disc is loaded, firmware version information and a confirmation message will appear.

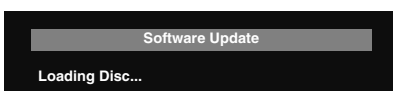

FUNCTION SETUP

7 Use [◀/▶] to select "Yes", then press [OK].

- Loading of the firmware will start.

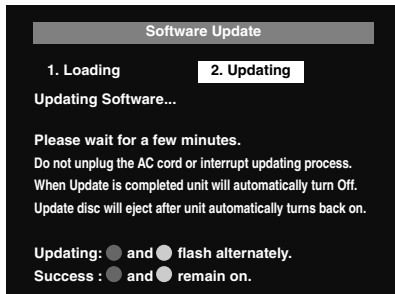
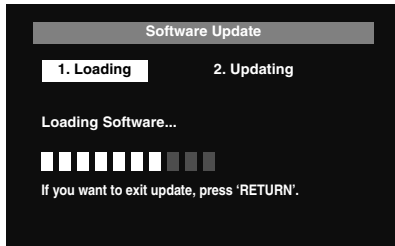

The indicators blinks for this procedure.

1. Start



2. Loading / Updating



3. Finish (Success)



(Error)*



* If the indicator shows Error...

- 1) Unplug the AC power cord and turn the unit again.
- 2) Confirm the current firmware version.
- 3) If the firmware version is updated, the software update has succeeded. If not, please follow the steps 2 to 8 on pages 42-43.

8 After the firmware update finishes, this unit will restart, and eject the disc automatically.

- Software updating is now complete. Please take out the firmware update disc.

Note

- You can check the current firmware version in "Current Version" in "Software Update" menu.
- Please do not unplug the AC power cord while executing "Software Update".
- All settings will remain the same even if you update the firmware version.

FUNCTION SETUP

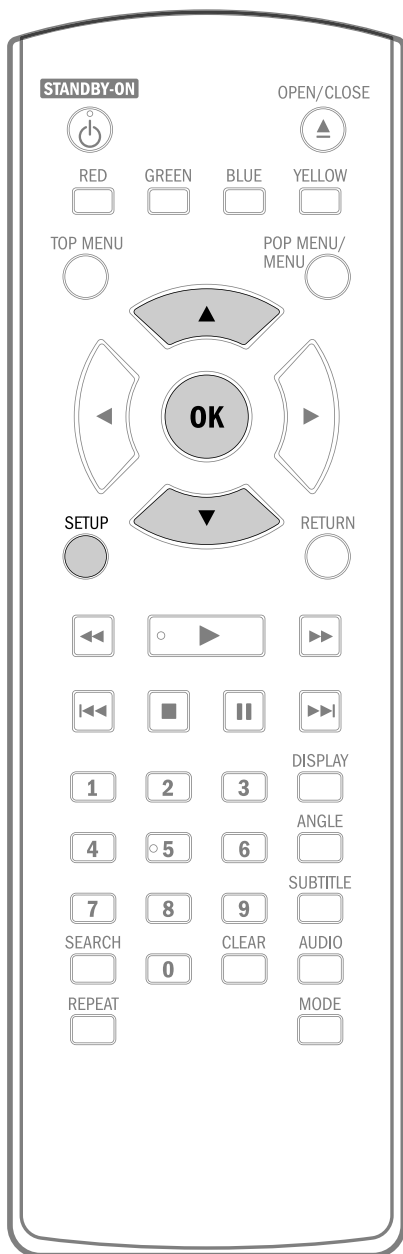

Initialize

Initialize the setting or SD Memory Card.

1 In stop mode, press [SETUP].

2 Use [▲ / ▼] to select , then press [OK].

3 Use [▲ / ▼] to select a desired option, then press [OK].

“Setup”:

Resets the setup menu to the default.

“Format SD Card”

(Available only when an SD Memory Card is inserted.):

Initializes the SD Memory Card. After confirmation message appears, use [▲ / ▼] to select “Yes”, then press [OK].

“Erase Saved BD-ROM Data (Player)”:

Clears the data saved for the BD-ROM contents, such as BD-ROM game scores, from this player.

“Erase Saved BD-ROM Data (SD Card)”

(Available only when an SD Memory Card is inserted.):

Clears the supplemental data for the BD-ROM playback, such as subtitle data, from the SD Memory Card.

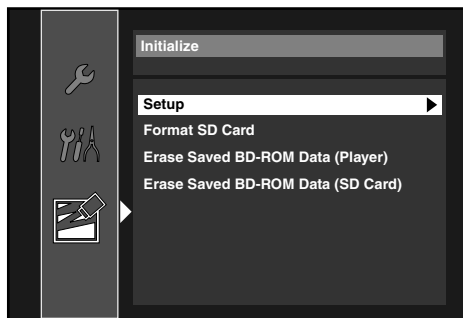

4 Press [OK]. (For “Setup” and “Format SD Card” only)

• Final confirmation message will appear. Select “Yes”, then press [OK].

5 Press [SETUP] to exit.

Note

• The setting for “Parental” will not be reset.

Caution

• Do not remove the SD Memory Card while executing the “Format SD Card” or the “Erase Saved BD-ROM Data (SD Card)”. It damages the card.

Troubleshooting

If the unit does not perform properly when operated as instructed in this manual, check the unit, consulting the following checklist.

Problem	Solution
No power	<ul style="list-style-type: none"> - Check if the AC cord is properly connected. - Unplug the AC cord once, and wait for 5-10 seconds and then plug it in again.
No sound or picture	<ul style="list-style-type: none"> - Check if the connected TV is turned on. - Check if the connections are made securely and correctly. - Check whether the connected TV or other device supports HDCP. (This unit will not output a video signal unless the other device supports HDCP.) - Check whether the output format of this unit (HDMI FORMAT) matches the supported input format of other connected device.
Distorted picture	<ul style="list-style-type: none"> - Sometimes a small amount of picture distortion may appear. This is not a malfunction. - Connect this unit directly to the TV. If the RCA audio / video cables are connected to a VCR, pictures may be distorted due to the copy right protection system.
Completely distorted picture or black / white picture with BD / DVD	<ul style="list-style-type: none"> - Make sure the disc is compatible with this unit.
No sound or distorted sound	<ul style="list-style-type: none"> - Adjust the volume. - Check if speakers are connected correctly. - Check the HDMI connections. - Check the settings in "Audio" menu.
Picture freezes momentarily during playback	<ul style="list-style-type: none"> - Check the disc for fingerprints / scratches and clean with a soft cloth wiping from center to edge. - Clean the disc.
Disc cannot be played back	<ul style="list-style-type: none"> - Clean the disc. - Ensure the disc label is facing up. - Check if the disc is defective by trying another disc. - Cancel the ratings control or change the control level. - Insert a correct disc that can be played back on this unit.
SD Memory Card cannot be read	<ul style="list-style-type: none"> - The format of the card does not match that accepted by this unit or the card is not compatible.
No return to start-up screen when disc is removed	<ul style="list-style-type: none"> - Reset this unit by turning it off, then on again.
The unit does not respond to the remote control	<ul style="list-style-type: none"> - Aim the remote control directly at infrared sensor window on the front panel. - Reduce the distance to infrared sensor window. - Replace the batteries in the remote control. - Re-insert the batteries with their polarities (+ / - signs) as indicated.
Buttons do not work or the unit stops responding	<ul style="list-style-type: none"> - To completely reset the unit, press and hold [⏻ STANDBY-ON] on the front panel for 10 seconds to shut down the unit or unplug the AC cord from the AC outlet for 5-10 seconds.
The unit does not respond to some operating commands during playback	<ul style="list-style-type: none"> - Operations may not be permitted by the disc. Refer to the instructions of the disc.
The unit cannot read BD / DVD / CD	<ul style="list-style-type: none"> - Condensation? (Let sit 1 or 2 hours) - You are attempting to playback a disc other than one with one of the Logos on page 14. - Wipe the dirt off the disc or replace the disc.
Angle does not switch	<ul style="list-style-type: none"> - The angle cannot be switched for BD / DVD which do not contain multiple angles. In some cases multiple angles are only recorded for specific scenes.
Playback does not start when the title is selected	<ul style="list-style-type: none"> - Check the settings in "Parental" menu.
The password for rating level has been forgotten	<ul style="list-style-type: none"> - Enter the default password "4737", then your forgotten password will be cleared.

Note

- Some functions are not available in specific modes, but this is not a malfunction. Read the description in this manual for details on correct operations.
- Some functions are prohibited on some discs.

Glossary

Analog Audio

An electrical signal that directly represents sound. Compare this to digital audio which can be an electrical signal, but is an indirect representation of sound. See also "Digital Audio".

Aspect Ratio

The width of a TV screen relative to its height. Conventional TVs are 4:3 (in other words, the TV screen is almost square); widescreen models are 16:9 (the TV screen is almost twice as wide as it is high).

BD-Java

With some BD which support Java applications, you can enjoy the interactive functions such as games or interactive menus.

Blu-ray Disc (BD)

Blu-ray Disc is a next generation optical video disc which is capable of storing much more data than a conventional DVD is. The large capacity makes it possible to benefit from the features such as high-definition videos, multi-channel surround sounds, interactive menus and so on.

Chapter

Just as a book is split up into several chapters, a title on a BD-video or DVD-video is usually divided into chapters. See also "Title".

Component Video Output

Each signal of luminance (Y) and component (P_B/C_B, P_R/C_R) is independent to output so that you can experience picture Color as it is. Also, due to compatibility with progressive video (525p/480p), you can experience higher-density picture than that in interlace (525i/480i).

Digital Audio

An indirect representation of sound by numbers. During recording, the sound is measured at discrete intervals (44,100 times a second for CD audio) by an analog-to-digital converter, generating a stream of numbers. On playback, a digital-to-analog converter generates an analog signal based on these numbers. See also "Sampling Frequency" and "Analog Audio".

Dolby Digital

The system to compress digital sound developed by Dolby Laboratories. It offers you sound of stereo (2ch) or multi-channel audio.

Dolby Digital Plus

Dolby Digital Plus is the next generation digital audio compression technology developed as an extension to Dolby Digital. Blu-ray Disc supports 7.1 multi-channel surround sound output.

Dolby TrueHD

Dolby TrueHD is a lossless coding technology developed for next generation optical discs. Blu-ray Disc supports 7.1 multi-channel surround sound output.

DTS (Digital Theater System)

DTS is a multi-channel surround sound system. By connecting to DTS decoder, you can enjoy movie dynamic and realistic sound like movie theater. DTS surround sound technologies were developed by DTS, Inc.

DTS-HD

DTS-HD is a lossless coding technology developed as an extension of the original DTS Coherent Acoustics format. Blu-ray Disc supports 7.1 multi-channel surround sound output.

HDMI (High-Definition Multimedia Interface)

A digital interface between audio and video source. It can transmit component video, audio, and control signal with one cable connection.

JPEG (Joint Photographic Experts Group)

JPEG is a method of compressing still picture files. You can copy JPEG files on BD-RE/-R, DVD, CD-RW/-R or SD Memory Card from a computer and play back the files in this unit.

PCM (Pulse Code Modulation)

The most common system of encoding digital audio, found on CD and DAT. Excellent quality that requires a lot of data compared to formats such as Dolby Digital and MPEG audio. For compatibility with digital audio recorders (CD, MD and DAT) and AV amplifiers with digital inputs, this unit can convert Dolby Digital, DTS, and MPEG audio to PCM. See also "Digital Audio".

Region Code

Regions associate discs and players with particular areas of the world. This unit will only play back discs that have compatible region codes. You can find the region code of your unit by looking on the rear panel. Some discs are compatible with more than one region (or all regions).

Sampling Frequency

The rate which sound is measured by a specified interval to turn into digital audio data. The numbers of sampling in one second defines as sampling frequency. The higher the rate, the better the sound quality.

Title

A collection of chapters on BD-video or DVD-video. See also "Chapter".

Track

Audio CD use tracks to divide up the content of a disc. The BD-video or DVD-video equivalent is called a chapter. See also "Chapter".

OTHERS

Language Code List

Language	Code	Language	Code	Language	Code	Language	Code
A-B		French [FRE]	5264	Macedonian	5957	Siswat	6565
Abkhazian	4748	Frisian	5271	Malagasy	5953	Slovak [SLO]	6557
Afar	4747	Galician	5358	Malay	5965	Slovenian	6558
Afrikaans	4752	Georgian	5747	Malayalam	5958	Somali	6561
Albanian	6563	German [GER]	5051	Maltese	5966	Spanish [SPA]	5165
Amharic	4759	Greek [GRE]	5158	Maori	5955	Sundanese	6567
Arabic	4764	Greenlandic	5758	Marathi	5964	Swahili	6569
Armenian	5471	Guarani	5360	Moldavian	5961	Swedish [SWE]	6568
Assamese	4765	Gujarati	5367	Mongolian	5960	T	
Aymara	4771	Hausa	5447	Nauru	6047	Tagalog	6658
Azerbaijani	4772	Hebrew	5569	Nepali	6051	Tajik	6653
Bashkir	4847	Hindi	5455	Norwegian [NOR]	6061	Tamil	6647
Basque	5167	Hungarian [HUN]	5467	O-R		Tatar	6666
Bengali;Bangla	4860	I-K		Occitan	6149	Telugu	6651
Bhutani	5072	Icelandic [ICE]	5565	Oriya	6164	Thai	6654
Bihari	4854	Indonesian	5560	Oromo (Afan)	6159	Tibetan	4861
Bislama	4855	Interlingua	5547	Panjabi	6247	Tigrinya	6655
Breton	4864	Interlingue	5551	Pashto;Pushto	6265	Tonga	6661
Bulgarian [BUL]	4853	Inupiak	5557	Persian	5247	Tsonga	6665
Burmese	5971	Irish [IRI]	5347	Polish [POL]	6258	Turkish [TUR]	6664
Byelorussian	4851	Italian [ITA]	5566	Portuguese [POR]	6266	Turkmen	6657
C-E		Japanese [JPN]	5647	Quechua	6367	Twi	6669
Cambodian	5759	Javanese	5669	Rhaeto-Romance	6459	U-Z	
Catalan	4947	Kannada	5760	Romanian [RUM]	6461	Ukrainian	6757
Chinese [CHI]	7254	Kashmiri	5765	Russian [RUS]	6467	Urdu	6764
Corsican	4961	Kazakh	5757	S		Uzbek	6772
Croatian	5464	Kinyarwanda	6469	Samoa	6559	Vietnamese	6855
Czech [CZE]	4965	Kirghiz	5771	Sangho	6553	Volapuk	6861
Danish [DAN]	5047	Kirundi	6460	Sanskrit	6547	Welsh	4971
Dutch [DUT]	6058	Korean [KOR]	5761	Scots Gaelic	5350	Wolof	6961
English [ENG]	5160	Kurdish	5767	Serbian	6564	Xhosa	7054
Esperanto	5161	L-N		Serbo-Croatian	6554	Yiddish	5655
Estonian	5166	Laothian	5861	Sesotho	6566	Yoruba	7161
F-H		Latin	5847	Setswana	6660	Zulu	7267
Faroese	5261	Latvian;Lettish	5868	Shona	6560		
Fiji	5256	Lingala	5860	Sindhi	6550		
Finnish [FIN]	5255	Lithuanian	5866	Singhalese	6555		

Note

- If you choose a language that has a 3-letter-language code (written in bracket), the code will be displayed every time you change the audio or subtitle language setting on page 27. If you choose any other languages, "----" will be displayed instead.

OTHERS

General

Signal system	NTSC color
Power requirements	120 V AC, 60 Hz
Power consumption	20 W (standby: 0.5 W)
Dimensions (width x height x depth)	14-3/16 x 2 x 8-16/8 inches (360 x 50 x 215mm)
Weight	4.2 lbs. (1.9 kg)
Operating temperature	41°F (5°C) to 104°F (40°C)
Operating humidity	Less than 80 % (no condensation)

Terminals

Rear	Video output			
	RCA jack x 1	1 Vp-p (75Ω)		
	Component video output			
	RCA jack x 3	Y: 1 Vp-p (75Ω)	P _B /C _B : 700 mVp-p (75Ω)	P _R /C _R : 700 mVp-p (75Ω)
	HDMI output			
	HDMI jack x 1	Video: 480p, 720p, 1080i, 1080p, 1080p24 / Audio		
Audio output (Analog)				
RCA jack x 2	L/R: 2 Vrms (output impedance: more than 1kΩ)			
Audio output (Digital)				
RCA jack x 1	500 mVp-p (75Ω)			

Note

- The specifications and design of this product are subject to change without notice.

Maintenance

Servicing

- Please refer to relevant topics on "Troubleshooting" on page 45 before returning the product.
- If this unit becomes inoperative, do not try to correct the problem by yourself. There are no user-serviceable parts inside. Turn the unit to the standby mode, unplug the power plug, and please contact 1-800-605-8610 or visit : www.magnavox.com/support

Cleaning the cabinet

- Wipe the front panel and other exterior surfaces of the unit with a soft cloth.
- Never use a solvent, thinner, benzene or alcohol to clean the unit. Do not spray insecticide liquid near the unit. Such chemicals may discolor the surface or damage the unit.

Cleaning discs

- When a disc becomes dirty, clean it with a cleaning cloth. Wipe the disc from the center to out. Do not wipe in a circular motion.
- Do not use solvents such as benzine, thinner, commercially available cleaners, detergent, abrasive cleaning agents or antistatic spray intended for analog records.

Cleaning the disc lens

- If this unit still does not perform properly although you refer to the relevant sections and to "Troubleshooting" in this manual, the laser optical pickup unit may be dirty. Consult your dealer or an authorized service center for inspection and cleaning of the laser optical pickup unit.

Disc handling

- Handle the discs so that fingerprints and dust do not adhere to the surfaces of the discs.
- Always store the disc in its protective case when it is not used.
- Note that discs with special shapes (heart-shaped discs, octagonal discs, etc.) cannot be played back on this unit. Do not attempt to playback such discs, as they may damage the unit.

IR signal check

- If the remote control is not working properly, you can use a digital camera (including a cellular phone with built-in camera) to see if it is sending out an infrared signal.
- **With a digital camera (including built-in cell phone cameras):**



Point a digital camera towards the remote control. Push any button on the remote control and look through the digital camera. If the infrared light appears through the camera, the remote control is working.

MEMO

MEMO

MAGNAVOX

LIMITED WARRANTY

FUNAI CORP. will repair this product, free of charge in the USA in the event of defect in materials or workmanship as follows:

DURATION:

PARTS: FUNAI CORP. will provide parts to replace defective parts without charge for one (1) year from the date of original retail purchase. Certain parts are excluded from this warranty.

LABOR: FUNAI CORP. will provide the labor without charge for a period of ninety (90) days from the date of original retail purchase.

LIMITS AND EXCLUSIONS:

THIS WARRANTY IS EXTENDED ONLY TO THE ORIGINAL RETAIL PURCHASER. A PURCHASE RECEIPT OR OTHER PROOF OF ORIGINAL RETAIL PURCHASE WILL BE REQUIRED TOGETHER WITH THE PRODUCT TO OBTAIN SERVICE UNDER THIS WARRANTY.

This warranty shall not be extended to any other person or transferee.

This warranty is void and of no effect if any serial numbers on the product are altered, replaced, defaced, missing or if service was attempted by an unauthorized service center. This limited warranty does not apply to any product not purchased and used in the United States.

This warranty only covers failures due to defects in material or workmanship which occur during normal use. It does not cover damage which occurs in shipment, or failures which are caused by repairs, alterations or products not supplied by FUNAI CORP., or damage, which results from accident, misuse, abuse, mishandling, misapplication, alteration, faulty installation, improper maintenance, commercial use such as hotel, rental or office use of this product, or damage which results from fire, flood, lightning or other acts of God.

THIS WARRANTY DOES NOT COVER PACKING MATERIALS, ANY ACCESSORIES (EXCEPT REMOTE CONTROL), ANY COSMETIC PARTS, COMPLETE ASSEMBLY PARTS, DEMO OR FLOOR MODELS.

FUNAI CORP. AND ITS REPRESENTATIVES OR AGENTS SHALL IN NO EVENT BE LIABLE FOR ANY GENERAL, INDIRECT OR CONSEQUENTIAL DAMAGES ARISING OUT OF OR OCCASIONED BY THE USE OF OR THE INABILITY TO USE THIS PRODUCT. THIS WARRANTY IS MADE IN LIEU OF ALL OTHER WARRANTIES, EXPRESS OR IMPLIED, AND OF ALL OTHER LIABILITIES ON THE PART OF FUNAI, ALL OTHER WARRANTIES INCLUDING THE WARRANTY OF MERCHANTABILITY AND FITNESS FOR A PARTICULAR PURPOSE, ARE HEREBY DISCLAIMED BY FUNAI AND ITS REPRESENTATIVES IN THE UNITED STATES.

ALL WARRANTY INSPECTIONS AND REPAIRS MUST BE PERFORMED BY AN AUTHORIZED SERVICE CENTER.

THIS WARRANTY IS ONLY VALID WHEN THE UNIT IS CARRIED-IN TO AN AUTHORIZED SERVICE CENTER.

THE PRODUCT MUST BE ACCOMPANIED BY A COPY OF THE ORIGINAL RETAIL PURCHASE RECEIPT. IF NO PROOF OF PURCHASE IS ATTACHED, THE WARRANTY WILL NOT BE HONORED AND REPAIR COSTS WILL BE CHARGED.

IMPORTANT:

THIS LIMITED WARRANTY GIVES YOU SPECIFIC LEGAL RIGHTS. YOU MAY HAVE OTHER RIGHTS THAT VARY FROM STATE TO STATE. IF, AT ANY TIME DURING THE WARRANTY PERIOD, YOU ARE UNABLE TO OBTAIN SATISFACTION WITH THE REPAIR OF THIS PRODUCT, PLEASE CONTACT FUNAI CORP.

ATTENTION:

FUNAI CORP. RESERVES THE RIGHT TO MODIFY ANY DESIGN OF THIS PRODUCT WITHOUT PRIOR NOTICE.

WARRANTY STATEMENT REGARDING NON AUTHORIZED REPAIRS:

To obtain warranty service, you must take the product, or deliver the product freight prepaid, in either its original packaging or packaging affording an equal degree of protection, to any AUTHORIZED SERVICE CENTER. FUNAI CORP. will not reimburse you for any service done by unauthorized service providers without prior written approval.

To locate your nearest AUTHORIZED SERVICE CENTER or for general service inquiries, please contact us at:

FUNAI SERVICE CORPORATION

Tel: 1-800-605-8610

www.magnavox.com/support

2200 Spiegel Drive, Groveport, OH 43125

